

**"Apollo"®** PowerPress  
VSH technology





**disclaimer:**

The technical data are non-binding and do not reflect the warranted characteristics of the products. They are subject to change. Please consult our General Terms and Conditions. Additional information is available upon request. It is the designer's responsibility to select products suitable for the intended purpose and to ensure that pressure ratings and performance data are not exceeded. The installation instructions should always be read and followed. The system must always be depressurized and drained before any components, whether defective or otherwise, are removed, modified or corrected.

# contents

<b>technical data</b>	<b>5</b>
system data	6
installation guidelines	7
<b>product range</b>	<b>9</b>
"Apollo" <sup>®</sup> PowerPress <sup>®</sup> EPDM fittings & valves	9
"Apollo" <sup>®</sup> PowerPress <sup>®</sup> large diameter EPDM fittings	17
"Apollo" <sup>®</sup> PowerPress <sup>®</sup> HNBR fittings & valves	23
"Apollo" <sup>®</sup> PowerPress <sup>®</sup> large diameter HNBR fittings	31
<b>terms &amp; conditions</b>	<b>32</b>

---



"Apollo"® PowerPress®

technical data



## system data

“Apollo”® PowerPress® is designed for Schedule 10-40 carbon steel pipe, available in sizes from ½” to 4”. All fittings and valves feature zinc-nickel coatings for corrosion resistance and EPDM or HNBR sealing elements. With the patented Leak Before Press® technology and color-coded Visual Control Ring (VCR), “Apollo”® PowerPress® ensures clear identification of pressed connections and optimally positions pipes for straighter, cleaner installations. “Apollo”® PowerPress® stands as the leader in quality and reliability, surpassing other carbon press systems.

### operating parameters

parameters	HNBR	EPDM
approved pipe material	<ul style="list-style-type: none"> <li>sch 10 &amp; sch 40</li> <li>ASTM A53</li> <li>ASTM A106</li> <li>ASTM A135</li> <li>ASTM A795</li> </ul>	<ul style="list-style-type: none"> <li>sch 10 &amp; sch 40</li> <li>ASTM A53</li> <li>ASTM A106</li> <li>ASTM A135</li> <li>ASTM A795</li> </ul>
max pressure	232 psi	232 psi
temperature range	-40°F to 194°F	-40°F to 302°F
applications	<ul style="list-style-type: none"> <li>general piping systems</li> <li>LP / natural gas / fuel oil</li> <li>industrial gas systems</li> <li>heating fuel oil</li> <li>engine oil</li> <li>hydraulic fluid</li> </ul>	<ul style="list-style-type: none"> <li>general piping systems</li> <li>heating and cooling</li> <li>industrial gas systems</li> <li>compressed air systems</li> <li>fire protection systems</li> <li>process and utility water systems</li> </ul>

### approved applications

service	pressure	temperature	EPDM	HNBR
natural gas / LP gas / fuel oil	125 psi max.	up to 140°F		✓
chilled water	232 psi	down to -40°F	✓	
hydronic heating	232 psi	0°F - 302°F	✓	
fire sprinkler	175 psi	ambient	✓	
low pressure steam	up to 15 psi	max. 302°F	✓	
heating fuel oil	125 psi	-40°F - 180°F		✓
diesel fuel	125 psi	ambient		✓
engine oil	150 psi	104°F		✓
gear grease	150 psi	ambient		✓
hydraulic fluid	232 psi	ambient		✓
transmission fluid	232 psi	-40°F - 180°F		✓
compressed air	232 psi	up to 140°F	✓	✓
vacuum	max. 29.2in Hg	up to 140°F	✓	✓
nitrogen	232 psi	up to 140°F	✓	✓
argon	232 psi	up to 140°F	✓	✓
carbon dioxide	232 psi	up to 140°F	✓	✓

### certifications & listings

	HNBR valves	HNBR fittings	EPDM valves	EPDM fittings
approvals & certifications	<ul style="list-style-type: none"> <li>CSA 6.32 / ANSI LC 4</li> <li>CRN</li> </ul>	<ul style="list-style-type: none"> <li>CSA 6.32 / ANSI LC 4</li> <li>CRN</li> </ul>	<ul style="list-style-type: none"> <li>IAPMO / ANSI Z1157</li> <li>CRN</li> </ul>	<ul style="list-style-type: none"> <li>FM 1920</li> <li>IAPMO / ANSI Z1157</li> <li>CRN</li> <li>UL 213</li> </ul>
compliances	<ul style="list-style-type: none"> <li>ASME B31</li> <li>ARRA</li> <li>NFPA 13, 13R, 13D, 54 &amp; 58</li> <li>BAA</li> <li>UPC*</li> <li>UMC*</li> <li>IPC*</li> <li>IFGC*</li> <li>National Plumbing Code of America</li> </ul>	<ul style="list-style-type: none"> <li>ASME B31</li> <li>ARRA</li> <li>NFPA 13, 13R, 13D, 54 &amp; 58</li> <li>UPC*</li> <li>UMC*</li> <li>IPC*</li> <li>IFGC*</li> <li>National Plumbing Code of America</li> </ul>	<ul style="list-style-type: none"> <li>ASME B31</li> <li>ARRA</li> <li>NFPA 13, 13R, 13D, 54 &amp; 58</li> <li>BAA</li> <li>UPC*</li> <li>UMC*</li> <li>IPC*</li> <li>IFGC*</li> <li>National Plumbing Code of America</li> </ul>	<ul style="list-style-type: none"> <li>ASME B31</li> <li>ARRA</li> <li>NFPA 13, 13R, 13D, 54 &amp; 58</li> <li>UPC*</li> <li>UMC*</li> <li>IPC*</li> <li>IFGC*</li> <li>National Plumbing Code of America</li> </ul>

### product features

- carbon steel
- patented Visu-Control Foil™ (LD sizes)
- break-away tabs, color-coded elements
- pipe guide protects & positions pipe
- deeper cups, protective shipping cap
- Leak Before Press®
- 15-year limited warranty (fittings)
- 5-year limited warranty (valves)

# installation guidelines

It is the responsibility of the end-user to follow all instructions for installing Apollo® PowerPress fittings and valves. Failure to follow these instructions and safe plumbing practices may result in extensive property damage, serious injury or death.

## 1. cut pipe to length

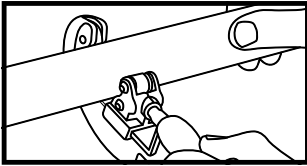

After measuring, the pipes can be cut to length using a pipe cutter, a fine-toothed handsaw or an electrical mechanical saw suitable for the pipe material. The pipe must always be cut completely through. Never partially cut the

pipe and break it off as this could cause leakage. When cutting already installed pipes, always take into account a minimum distance to weldings and bends of 4" for pipe sizes 1/2"- 1-1/4", and 3x outside diameter for pipe sizes 1-1/2"- 2".

**Do not use oil-cooled saws, grinding wheels or flame cutters.**

## 2. deburr pipe

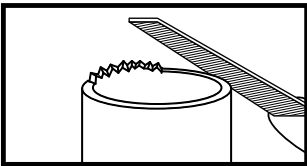

Pipe ends must be carefully and thoroughly deburred in and outside after being cut to length in order to avoid damage to the sealing element when inserting the pipe into the press fitting. A file, hand deburrer, or an electrical

pipe deburrer (suitable for the material) may be used to deburr both inside and outside of the pipe. Burrs sticking to the pipe must be removed.

## 3. clean outside pipe surface

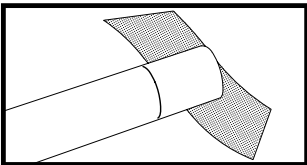

Always ensure that any dirt, scale, excessive paint or corrosion particles are removed from the surface of the pipe. This can be done with a wire brush or fine grit sand paper. The pipe surface of the pipe must be smooth, free of

indentations, pits and deformations and must be free of oil and grease.

## 4. mark insertion depth

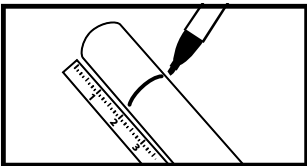

The required insertion depth must be marked on the pipe or the press fitting (the latter for fittings with pipe ends) in order to guarantee a safe and proper joint. The pressing operation behind the bead is of crucial importance for the tensile

strength. The marking on the pipe must remain visible (but close to the fitting) after the connection is pressed to identify any movement before or after pressing.

nominal pipe size (in.)	Insertion Depth (in.)
1/2	1.1
3/4	1.2
1	1.4
1 1/4	1.9
1 1/2	1.9
2	2.1
2 1/2	1.9
3	2.3
4	3.1

## 5. check fitting & Pipe

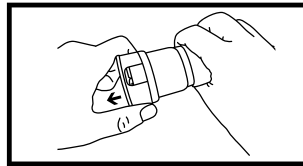

Before assembly, the protective cap must first be removed from fitting. Next, the fitting must be checked to ensure that the sealing element are present and correctly positioned. The pipe, fitting and sealing element must be examined

for any foreign materials (e.g. dirt, burrs) and removed, if present. Please make sure that the Visual Control Ring (VCR) ring is properly aligned before pressing.

## 6. insert Pipe

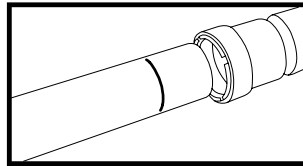

Insert the pipe carefully into the press fitting up to the marked insertion depth, without tilting, pushing it in the direction of the axis. The insertion depth marking must remain visible. In the case of fittings without a stop the fittings

should be inserted at least as far as the marked insertion depth. Rough and careless insertion of the pipe into the press fitting may result in damage to the sealing element and is therefore not permitted.

## 7. press the connection

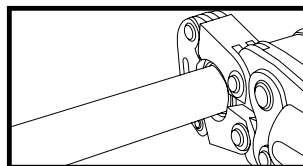

Before starting to press, the press jaws and slings must be checked for dirt or debris, and removed if present. Furthermore, the press tool must be in good condition and properly maintained in accordance with the instructions for

the device, per the manufacturer's instructions. In order to create a correctly pressed connection, the groove of the press tool must enclose the press fitting sealing element bead. Once the pressing has started, always complete the press cycle and under no circumstances interrupt the process.

**It is not permitted to press a connection more than once.**

## 8. verify press connection

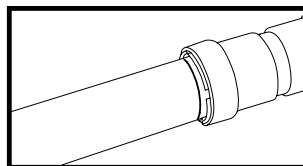

Once the tool has fully cycled, the pressed connection must be visually inspected to ensure a proper connection has been made. When the press tool has fully cycled, the Visual Control Ring (VCR) tabs will break away,

indicating a complete press. In some cases, it is possible for a VCR tab to get stuck between the inner diameter of the fitting and the pipe after breaking away, giving off the appearance of an un-pressed fitting. This shouldn't alarm the installer, as it will have no bearing on the performance or functionality of the fitting itself. Simply remove the tab by hand, or, by using a thin tool such as a flat head screwdriver.



"Apollo"® PowerPress®

# EPDM fittings & valves



**89FVE non-gas ball valve EPDM**  
(press x press)



**description**

the “Apollo”® PowerPress® 89FV ball valve is ideal for installation in chilled water, compressed air, hydronic heating and fire sprinkler applications. This valve design significantly reduces installation time and helps maintain a clean working environment. the “Apollo”® PowerPress® is designed for steel pipe, schedules 10 to 40, as defined by ASTM A53, A106, A135 and A795 standards.

**standard materials list**

component	material
body	carbon steel (ASTM A216-WCB)
seat	reinforced PTFE
ball	stainless steel (ASTM A276-316)
stem packing	multi-fill PTFE
nut	corrosion resistant plated steel
stem	stainless steel (ASTM A276-316)
retainer	carbon steel (ASTM A108-12L14)
sealing element	EPDM
handle	plated steel / insulated polyvinyl
gland	carbon steel (ASTM A108-1215)
stem bearing	reinforced PTFE
body seal	PTFE

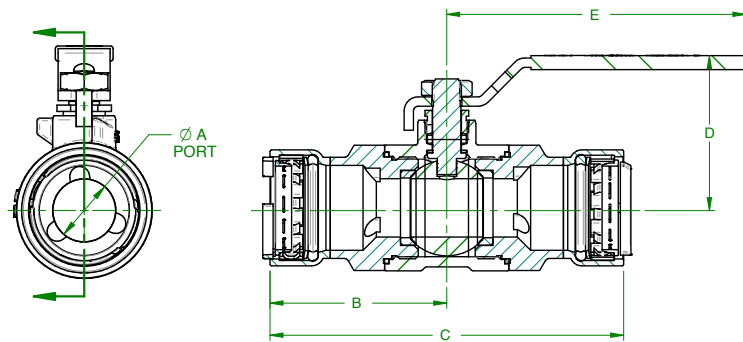

**dimensions**

size	item no.	weight [lb]	a	b	c	d	e
½"	89FVE4301	0.60	0.50	2.08	4.16	1.74	3.85
¾"	89FVE4401	0.90	0.75	2.28	4.55	1.96	3.85
1"	89FVE4501	1.40	1.00	2.72	5.44	2.29	4.76
1½"	89FVE4601	4.20	1.25	3.41	6.82	3.20	7.76
2"	89FVE4701	4.80	1.50	3.62	7.24	3.30	7.76

**specifications**

- patented visual control ring (green)
- EPDM sealing element
- full-port flow
- adjustable stem packing
- fast, reliable, economical press installation
- Ridgid® & milwaukee press tool compatible
- leak before press® technology
- blowout-proof stem
- corrosion resistant materials
- 100% factory tested
- silicone free assembly
- made in USA, ARRA compliant

max. operating pressure	operating temperature
200 psi	-40°F to -302°F

**options**

(-01)	standard (PTFE packing, RPTFE body seal)
(-02)	grounded stem
(-04)	2¼" stem extensions
(-11)	therma-seal™ insulating tee handle
(-24)	graphite stem packing
(-27)	SS latch-lock lever & nut
(-32)	SS tee handle & nut
(-39)	SS hi-rise locking wheel handle with SS nut
(-47)	SS latch lock oval handle
(-48)	SS oval handle (no latch)
(-49)	assembled dry
(-60)	grounded ball & stem

**approved application**

- chilled water
- hydronic heating (50% glycol max)
- low pressure steam (15 psi max)
- fire sprinkler
- service<sup>(1)</sup>

**compliant with**

- uniform plumbing code (UPC)
- international plumbing code (IPC)
- national plumbing code of canada

**certifications & listings**

- IAPMO/ANSI - Z1157
- CRN #0C10908 ADD11

<sup>(1)</sup>not suitable for flammable gas

**400 coupling EPDM**  
(2 x press)

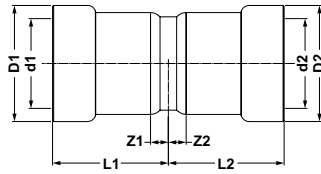

size	item no.	I1/I2	z1/z2	weight [lb]
½"	PWR7480000	1.34	0.24	0.29
¾"	PWR7480011	1.46	0.24	0.38
1"	PWR7480022	1.65	0.23	0.56
1¼"	PWR7480033	2.19	0.30	0.93
1½"	PWR7480044	2.26	0.33	1.18
2"	PWR7480055	2.38	0.30	1.55

**401 coupling - no stop EPDM**  
(2 x press)

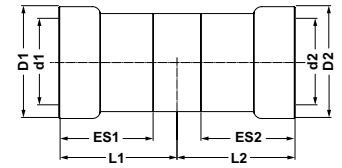

size	item no.	I1/I2	es1/es2	weight [lb]
½"	PWR7480066	1.55	1.10	0.32
¾"	PWR7480077	1.64	1.22	0.41
1"	PWR7480088	1.84	1.42	0.62
1¼"	PWR7480099	2.34	1.89	0.97
1½"	PWR7480101	2.50	1.93	1.27
2"	PWR7480110	2.56	2.09	1.65

**401R coupling - reducing EPDM**  
(2 x press)

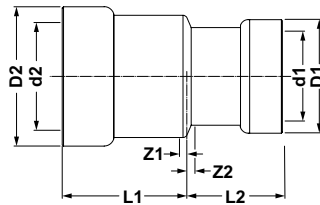

size	item no.	I1	I2	z1	z2	weight [lb]
¾" x ½"	PWR7483025	1.33	1.14	0.11	0.04	0.35
1" x ½"	PWR7483036	1.61	1.13	0.19	0.03	0.33
1" x ¾"	PWR7483047	1.55	1.24	0.13	0.02	0.37
1¼" x ¾"	PWR7483058	2.15	1.24	0.26	0.02	0.36
1¼" x 1"	PWR7483069	2.07	1.43	0.18	0.01	0.60
1½" x 1¼"	PWR7483071	2.09	1.95	0.16	0.06	0.80
2" x 1¼"	PWR7483080	2.39	1.95	0.31	0.06	0.98
2" x 1½"	PWR7483091	2.33	2.00	0.24	0.07	1.22

**403 adapter - female EPDM**  
(press x FPT)

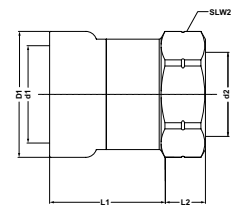

size	item no.	I1	I2	z1	z2	slw2	weight [lb]
½" x FPT ½"	PWR7480902	1.26	0.57	0.16	0.00	1.10	0.22
¾" x FPT ½"	PWR7480913	1.32	0.63	0.10	0.02	1.42	0.38
¾" x FPT ¾"	PWR7480924	1.30	0.63	0.08	0.00	1.42	0.33
1" x FPT ½"	PWR7480935	1.52	0.71	0.10	0.10	1.61	0.60
1" x FPT ¾"	PWR7480946	1.48	0.71	0.06	0.08	1.61	0.53
1" x FPT 1"	PWR7480957	1.56	0.71	0.14	0.00	1.61	0.45
1¼" x FPT ½"	PWR7480968	2.05	0.79	0.16	0.16	1.97	1.07
1¼" x FPT ¾"	PWR7480979	2.11	0.69	0.22	0.06	1.97	0.98
1¼" x FPT 1"	PWR7480981	2.07	0.79	0.18	0.04	1.97	0.93
1¼" x FPT 1¼"	PWR7480990	1.97	0.83	0.08	0.00	1.97	0.74
1½" x FPT ½"	PWR7481001	2.09	0.85	0.16	0.22	2.24	1.44
1½" x FPT ¾"	PWR7481012	2.11	0.79	0.18	0.16	2.24	1.34
1½" x FPT 1"	PWR7481023	2.17	0.79	0.24	0.04	2.24	1.30
1½" x FPT 1¼"	PWR7481034	2.09	0.79	0.16	0.02	2.24	0.80
1½" x FPT 1½"	PWR7481045	2.01	0.81	0.08	0.04	2.24	0.90
2" x FPT ½"	PWR7481056	2.46	0.79	0.37	0.18	2.76	2.01
2" x FPT ¾"	PWR7481067	2.46	0.79	0.37	0.16	2.76	1.95
2" x FPT 1"	PWR7481078	2.46	0.79	0.37	0.04	2.76	1.86
2" x FPT 1¼"	PWR7481089	2.46	0.79	0.37	0.02	2.76	1.69
2" x FPT 1½"	PWR7481091	2.32	0.79	0.24	0.02	2.76	1.64
2" x FPT 2"	PWR7481100	2.22	0.79	0.14	0.00	2.76	1.21

### 404 adapter - male EPDM

(press x MPT)

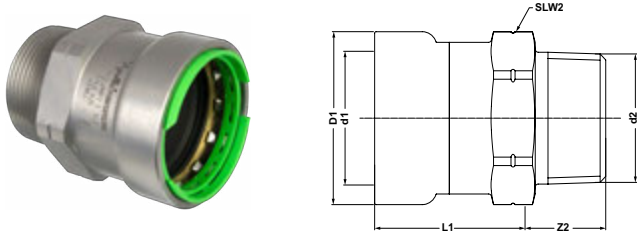

size	item no.	l1	l2	slw2	weight [lb]
½" x MPT ½"	PWR7480847	1.38	0.61	1.10	0.21
¾" x MPT ¾"	PWR7480858	1.40	0.63	1.42	0.30
1" x MPT 1"	PWR7480869	1.61	0.89	1.61	0.43
1¼" x MPT 1¼"	PWR7480871	2.12	0.77	1.97	0.73
1½" x MPT 1½"	PWR7480880	2.13	0.77	2.24	0.89
2" x MPT 2"	PWR7480891	2.33	0.78	2.76	1.23

### 406 45° elbow EPDM

(2 x press)

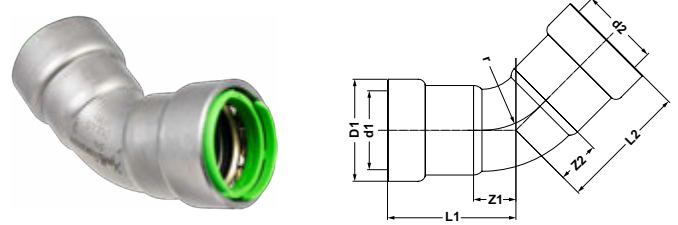

size	item no.	l1/l2	z1/z2	r	weight [lb]
½"	PWR7480242	1.59	0.49	0.98	0.32
¾"	PWR7480253	1.79	0.57	1.18	0.44
1"	PWR7480264	2.11	0.69	1.50	0.70
1¼"	PWR7480275	2.78	0.89	1.77	1.09
1½"	PWR7480286	2.91	0.98	1.97	1.44
2"	PWR7480297	3.29	1.20	2.56	2.03

### 406-2 45° street elbow EPDM

(press x street Ø)

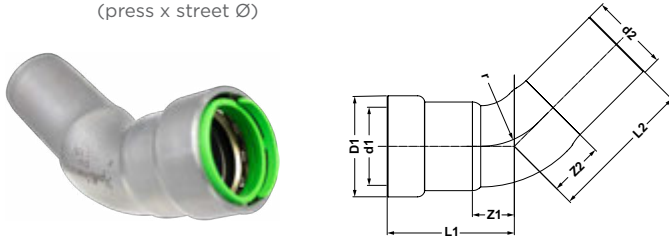

size	item no.	l1	l2	z1	r	weight [lb]
½"	PWR7480308	1.59	2.13	0.49	0.98	0.34
¾"	PWR7480319	1.81	2.26	0.59	1.18	0.45
1"	PWR7480321	2.13	2.68	0.71	1.50	0.71
1¼"	PWR7480330	2.78	3.24	0.89	1.77	1.10
1½"	PWR7480341	3.31	3.35	1.38	1.97	1.46
2"	PWR7480352	3.31	3.99	1.22	2.56	2.17

### 407 90° elbow EPDM

(2 x press)

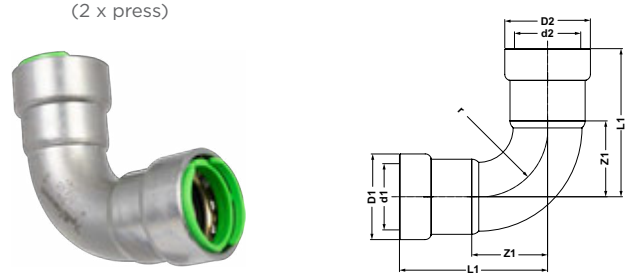

size	item no.	l1/l2	z1/z2	r	weight [lb]
½"	PWR7480121	2.17	1.06	0.98	0.39
¾"	PWR7480132	2.48	1.26	1.18	0.53
1"	PWR7480143	2.99	1.57	1.50	0.85
1¼"	PWR7480154	3.80	1.91	1.77	1.33
1½"	PWR7480165	4.06	2.13	1.97	1.77
2"	PWR7480176	4.78	2.70	2.56	2.57

**407-2 90° street elbow EPDM**  
(2 x press)

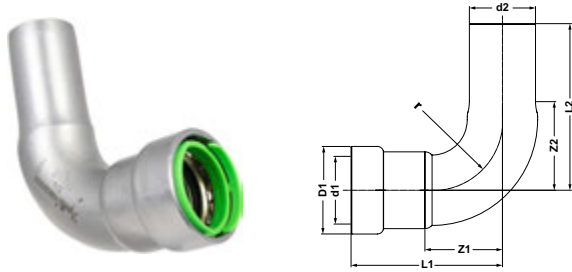

size	item no.	l1	l2	z1	r	weight [lb]
½"	PWR7480187	2.17	2.70	1.06	0.98	0.40
¾"	PWR7480198	2.48	2.95	1.26	1.18	0.55
1"	PWR7480209	2.99	3.56	1.57	1.50	0.89
1¼"	PWR7480211	3.80	4.27	1.91	1.77	1.34
1½"	PWR7480220	4.47	4.49	2.54	1.97	1.78
2"	PWR7480231	4.78	5.49	2.70	2.56	2.72

**411 tee EPDM**  
(3 x press)

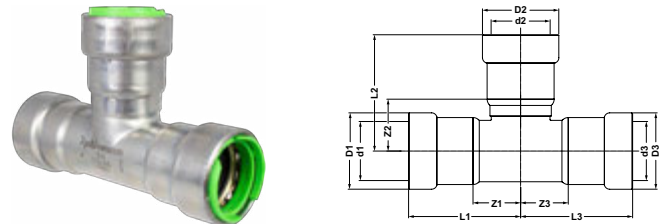

size	item no.	l1/l3	l2	z1/z3	z2	weight [lb]
½"	PWR7480363	2.05	2.09	0.94	0.98	0.57
¾"	PWR7480374	2.24	2.30	1.02	1.08	0.74
1"	PWR7480385	2.60	2.66	1.18	1.24	1.14
1¼"	PWR7480396	3.23	3.35	1.34	1.46	1.74
1½"	PWR7480407	3.48	3.50	1.56	1.57	2.33
2"	PWR7480418	3.78	3.92	1.69	1.83	3.15

**411R tee - reducing EPDM**  
(3 x press)

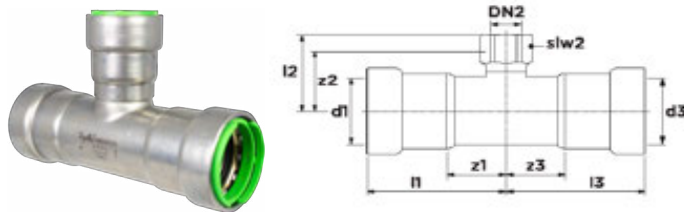

size	item no.	l1/l3	l2	z1/z3	z2	weight [lb]
¾" x ¾" x ½"	PWR7480429	2.24	2.19	1.02	1.08	0.70
1" x 1" x ½"	PWR7480431	2.60	2.34	1.18	1.24	1.00
1" x 1" x ¾"	PWR7480440	2.60	2.46	1.18	1.24	1.04
1¼" x 1¼" x ½"	PWR7483003	3.22	2.50	1.33	1.39	1.24
1¼" x 1¼" x ¾"	PWR7483014	3.22	2.60	1.33	1.38	1.43
1¼" x 1¼" x 1"	PWR7480451	3.23	2.81	1.34	1.40	1.58
1½" x 1½" x ½"	PWR7480462	3.48	2.58	1.56	1.48	1.90
1½" x 1½" x ¾"	PWR7480473	3.48	2.69	1.56	1.47	1.94
1½" x 1½" x 1"	PWR7480484	3.48	2.89	1.56	1.48	2.02
1½" x 1½" x 1¼"	PWR7480495	3.48	3.43	1.56	1.54	2.21
2" x 2" x ½"	PWR7480506	3.78	2.87	1.69	1.77	2.55
2" x 2" x ¾"	PWR7480517	3.78	2.99	1.69	1.77	2.58
2" x 2" x 1"	PWR7480528	3.78	3.19	1.69	1.77	2.70
2" x 2" x 1¼"	PWR7480539	3.78	3.72	1.69	1.83	2.88
2" x 2" x 1½"	PWR7480541	3.78	3.80	1.69	1.87	2.98

**4712 tee - female EPDM**  
(press x press x FPT)

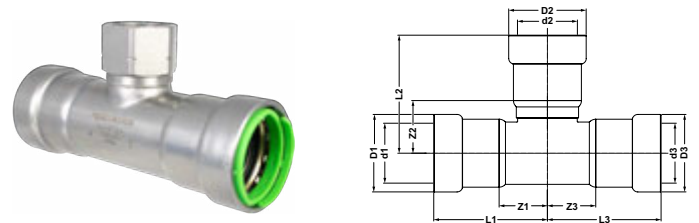

size	item no.	l1/l3	l2	z1/z3	z2	slw2	weight [lb]
¾" x ¾" x FPT ½"	PWR7480550	2.24	2.24	1.02	1.03	1.10	0.64
¾" x ¾" x FPT ¾"	PWR7480561	2.24	1.71	1.02	1.06	1.26	0.69
1" x 1" x FPT ½"	PWR7480572	2.60	1.81	1.18	1.19	1.10	0.96
1" x 1" x FPT ¾"	PWR7480583	2.60	1.87	1.18	1.22	1.26	0.96
1¼" x 1¼" x FPT ½"	PWR7480594	3.23	1.97	1.34	1.34	1.10	1.40
1¼" x 1¼" x FPT ¾"	PWR7483102	3.22	2.02	1.33	1.37	1.26	1.27
1¼" x 1¼" x FPT 1"	PWR7483113	3.22	2.17	1.33	1.40	1.61	1.41
1½" x 1½" x FPT ½"	PWR7480605	3.48	2.05	1.56	1.43	1.10	1.87
1½" x 1½" x FPT ¾"	PWR7480616	3.48	2.11	1.56	1.46	1.26	1.85
1½" x 1½" x FPT 1"	PWR7480627	3.48	2.26	1.56	1.49	1.61	1.95
1½" x 1½" x FPT 1¼"	PWR7480638	3.48	2.36	1.56	1.57	1.97	1.92
2" x 2" x FPT ½"	PWR7480649	3.78	2.34	1.69	1.72	1.10	2.47
2" x 2" x FPT ¾"	PWR7480651	3.78	2.40	1.69	1.75	1.26	2.49
2" x 2" x FPT 1"	PWR7480660	3.78	2.56	1.69	1.78	1.61	2.60
2" x 2" x FPT 1¼"	PWR7480671	3.78	2.66	1.69	1.87	1.97	2.82
2" x 2" x FPT 1½"	PWR7480682	3.78	2.66	1.69	1.87	2.36	3.04

**417 cap EPDM**  
(1 x press)

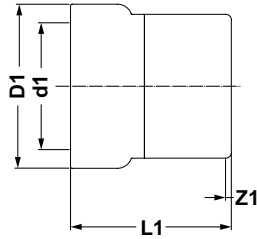

size	item no.	l1	z1	weight [lb]
½"	PWR7481232	1.38	0.28	0.17
¾"	PWR7481243	1.48	0.26	0.22
1"	PWR7481254	1.69	0.28	0.47
1¼"	PWR7481265	2.20	0.31	0.58
1½"	PWR7481276	2.24	0.31	0.74
2"	PWR7481287	2.44	0.35	0.98

**418 fitting reducer EPDM**  
(street Ø x press)

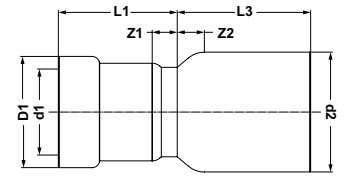

size	item no.	l1	l2	z2	weight [lb]
Ø ¾" x ½"	PWR7480693	1.37	1.15	0.04	0.29
Ø 1" x ½"	PWR7480704	1.56	1.15	0.04	0.40
Ø 1" x ¾"	PWR7480715	1.45	1.26	0.04	0.41
Ø 1¼" x 1"	PWR7480748	1.88	1.46	0.04	0.75
Ø 1½" x ¾"	PWR7480761	2.48	1.80	0.58	0.76
Ø 1½" x 1"	PWR7480770	1.94	1.46	0.04	0.88
Ø 1½" x 1¼"	PWR7480781	1.88	1.93	0.04	0.95
Ø 2" x 1"	PWR7480814	2.71	1.98	0.56	1.13
Ø 2" x 1¼"	PWR7480825	1.88	1.93	0.04	1.37
Ø 2" x 1½"	PWR7480836	1.95	1.97	0.04	1.32

**4733 union EPDM**  
(2 x press)

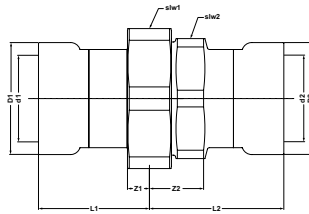

size	item no.	l1	l2	z1	z2	slw1	slw2	weight [lb]
½"	PWR7481111	1.74	2.04	0.65	0.94	1.61	1.42	0.49
¾"	PWR7481122	2.13	2.00	0.93	0.80	1.61	1.42	0.67
1"	PWR7481133	2.15	2.50	0.76	1.10	2.17	1.97	1.01
1¼"	PWR7481144	2.10	2.88	0.21	0.97	2.76	2.36	1.64
1½"	PWR7481155	2.97	2.85	1.04	0.92	2.76	2.36	2.23
2"	PWR7481166	3.31	3.31	1.21	1.21	3.35	2.95	2.90

**4734 union - female EPDM**  
(press x FPT)

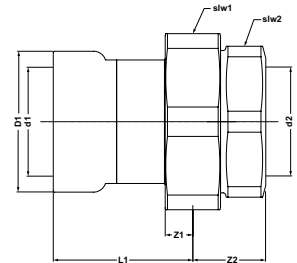

size	item no.	l1	l2	z1	z2	slw1	slw2	weight [lb]
½" x FPT ½"	PWR7483245	1.83	0.96	0.73	0.96	1.61	1.42	0.49
¾" x FPT ¾"	PWR7483256	2.22	0.91	1.00	0.91	1.61	1.42	0.67
1" x FPT 1"	PWR7483267	2.27	1.16	0.85	1.16	2.17	1.97	1.01
1¼" x FPT 1¼"	PWR7483278	2.22	1.23	0.33	1.23	2.76	2.36	1.64
1½" x FPT 1½"	PWR7483289	3.09	1.16	1.16	1.16	2.76	2.36	2.23
2" x FPT 2"	PWR7483291	3.46	1.41	1.37	1.41	3.35	2.95	2.90

4771 flange adapter - class 150 EPDM  
(press x flange)

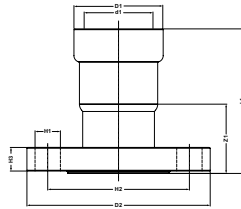

size	item no.	l1	z1	k2	b2	D2	d2-2	n2	weight [lb]
½"	PWR7481177	2.42	1.32	2.38	0.63	3.54	0.63	4	1.16
¾"	PWR7481188	2.62	1.40	3.25	0.63	3.94	0.63	4	1.63
1"	PWR7481199	2.93	1.52	3.13	0.63	4.33	0.63	4	2.23
1¼"	PWR7481201	3.56	1.67	3.50	0.63	4.53	0.63	4	2.81
1½"	PWR7481210	3.80	1.87	3.88	0.63	4.92	0.63	4	3.69
2"	PWR7481221	3.90	1.81	4.74	0.63	5.91	0.75	4	5.44





# "Apollo"® PowerPress®

## EPDM large diameter



**406-LD 45° elbow EPDM**  
(press x press)

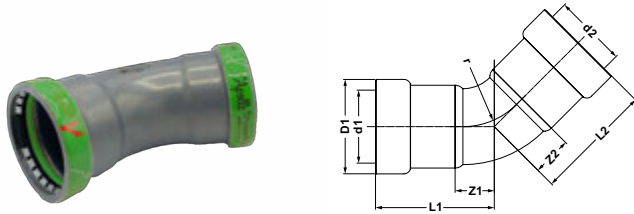

size	item no.	L1	L2	Z1	Z2	D1	d1	D2	d2	weight [lb]
2½"	123461308	3.92	3.92	2.05	2.05	3.54	2.93	3.54	2.93	2.48
3"	123461309	4.69	4.69	2.38	2.38	4.17	3.56	4.17	3.56	3.47
4"	123461310	6.14	6.14	3.01	3.01	5.20	4.58	5.20	4.58	5.69

**406-2-LD 45° street elbow EPDM**  
(press x FTG)

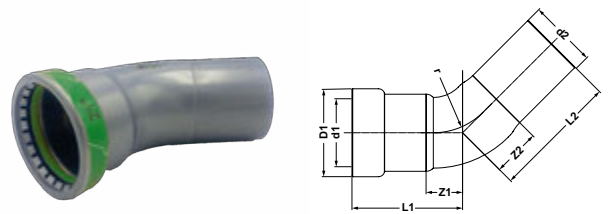

size	item no.	L1	L2	Z1	Z2	D1	d1	d2	weight [lb]
2½"	123461311	3.92	4.23	2.05		3.54	2.93	2.87	2.38
3"	123461312	4.69	4.57	2.38		4.17	3.56	3.50	3.26
4"	123461313	6.14	5.94	3.01		5.20	4.58	4.49	5.36

**407-LD 90° elbow EPDM**  
(press x press)

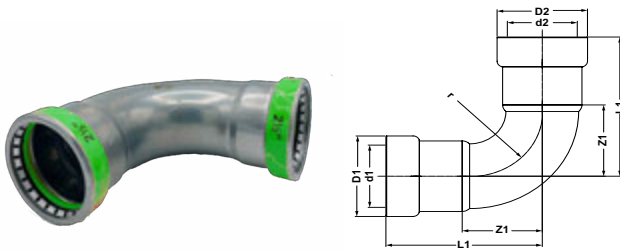

size	item no.	L1	L2	Z1	Z2	D1	d1	D2	d2	weight [lb]
2½"	123461314	5.98	5.98	4.11	4.11	3.54	2.93	3.54	2.93	3.31
3"	123461315	7.09	7.09	4.78	4.78	4.17	3.56	4.17	3.56	4.67
4"	123461316	9.25	9.25	6.12	6.12	5.20	4.58	5.20	4.58	7.60

**407-2-LD 90° street elbow EPDM**  
(press x FPT)

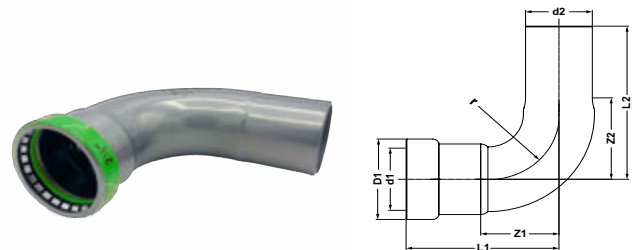

size	item no.	L1	L2	Z1	Z2	D1	d1	d2	weight [lb]
2½"	123461317	5.98	5.98	4.11		3.54	2.93	2.87	3.24
3"	123461318	7.09	6.97	4.78		4.17	3.56	3.50	4.42
4"	123461319	9.25	9.06	6.12		5.20	4.58	4.49	7.18

**403-LD adapter-female EPDM**  
(press x FTG)

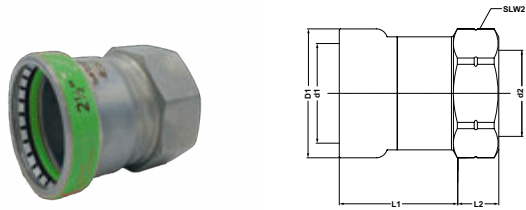

size	item no.	L1	Z2	D1	d1	d2	SLW2	weight [lb]
2½"	123461320			3.54	2.93	2.88		1.83
3"	123461321			4.17	3.56	3.50		2.35
4"	123461322			5.20	4.58	4.50		3.35

**404-LD adapter-male EPDM**  
(press x MPT)

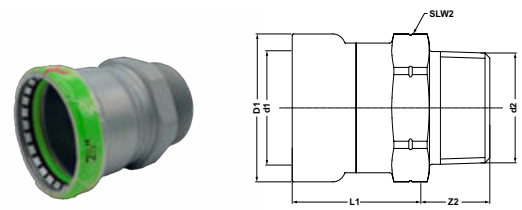

size	item no.	L1	Z2	D1	d1	d2	SLW2	weight [lb]
2½"	123461323			3.54	2.93	2.88		1.72
3"	123461324			4.17	3.56	3.50		2.34
4"	123461325			5.20	4.58	4.50		4.12

**417-LD cap EPDM**  
(press)

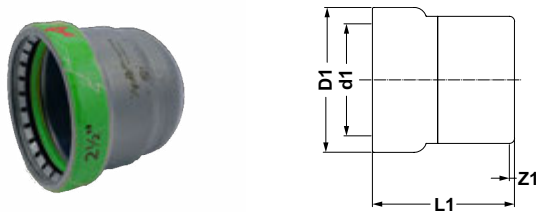

size	item no.	L1	Z1	D1	d1	weight [lb]
2½"	123461326	3.60	1.73	3.54	2.93	1.30
3"	123461327	4.21	1.91	4.17	3.56	1.70
4"	123461328	5.39	2.26	5.20	4.58	2.70

**401-LD coupling - no stop EPDM**  
(press x press)

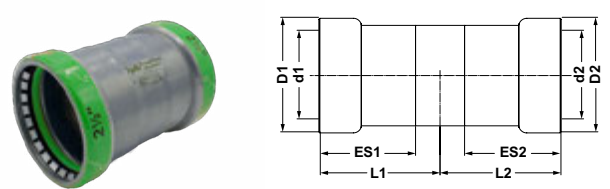

size	item no.	L1	L2	ES1	ES2	D1	d1	D2	d2	weight [lb]
2½"	123461329	2.46	2.46	1.87	1.87	3.54	2.93	3.54	2.93	1.73
3"	123461330	2.99	2.99	2.30	2.30	4.17	3.56	4.17	3.56	2.41
4"	123461331	3.94	3.94	3.13	3.13	5.20	4.58	5.20	4.58	4.01

**400-LD coupling EPDM**  
(press x press)

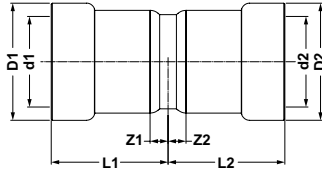

size	item no.	L1	L2	Z1	Z2	D1	d1	D2	d2	weight [lb]
2½"	123461332	2.46	2.46	0.59	0.59	3.54	2.93	3.54	2.93	1.73
3"	123461333	2.99	2.99	0.69	0.69	4.17	3.56	4.17	3.56	2.43
4"	123461334	3.94	3.94	0.81	0.81	5.20	4.58	5.20	4.58	3.96

**418-LD fitting reducer EPDM**  
(FTG x press)

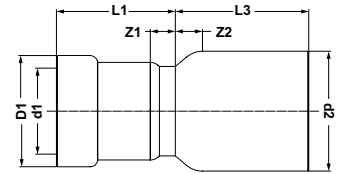

size	item no.	L1	L2	Z1	Z2	D1	d1	d2	weight [lb]
2½" x 1"	123461335	3.44	1.38			1.78	1.36	2.87	1.18
2½" x 1¼"	123461337	3.37	1.82			2.20	1.71	2.87	1.30
2½" x 1½"	123461336	3.30	1.87			2.44	1.95	2.87	1.41
2½" x 2"	123461338	3.13	1.95			2.89	2.42	2.87	1.49
3" x 1¼"	123461340	4.12	1.83			2.20	1.71	3.50	1.77
3" x 1½"	123461339	4.07	1.88			2.44	1.95	3.50	1.88
3" x 2"	123461341	4.26	1.96			2.89	2.42	3.50	1.66
3" x 2½"	123461342	3.81	1.90			3.54	2.93	3.50	1.95
4" x 1½"	123461343	5.56	1.88			2.44	1.95	4.49	3.07
4" x 2"	123461344	5.40	1.96			2.89	2.42	4.49	3.11
4" x 2½"	123461345	5.15	1.90			3.54	2.93	4.49	3.04
4" x 3"	123461346	5.03	2.33			4.17	3.56	4.49	3.26

**4771-LD flange adapter (class 150) EPDM**  
(press x FLG)

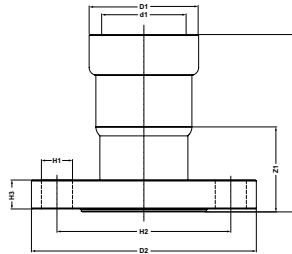

size	item no.	L1	Z1	D1	d1	D2	H1	H2	H3	weight [lb]
2½"	123461347	3.12	1.25	3.54	2.93	7.01	0.75	5.51	0.88	8.43
3"	123461348	3.78	1.48	4.17	3.56	7.48	0.75	6.00	0.94	9.88
4"	123461349	4.72	1.59	5.20	4.58	9.02	0.75	7.50	0.94	13.87

**4712-LD tee-female EPDM**  
(press x press x FTG)

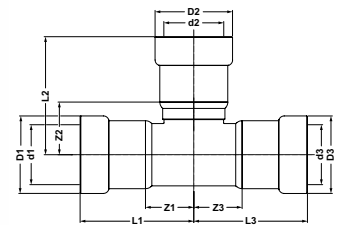

size	item no.	L1	L2	L3	Z1	Z2	Z3	weight [lb]
2½"	123461350	3.15	1.40	3.15	1.28		1.28	2.24
3"	123461351	3.74	1.53	3.74	1.44		1.44	3.10
4"	123461352	4.72	1.77	4.72	1.59		1.59	4.50

size	item no.	D1	d1	d2	D3	d3	slw2	weight [lb]
2½"	123461350	3.54	2.93	1.05	3.54	2.93	1.26	2.24
3"	123461351	4.17	3.56	1.05	4.17	3.56	1.26	3.10
4"	123461352	5.20	4.58	1.05	5.20	4.58	1.26	4.50

**411R-LD tee-reducing EPDM**  
(press x press x press)

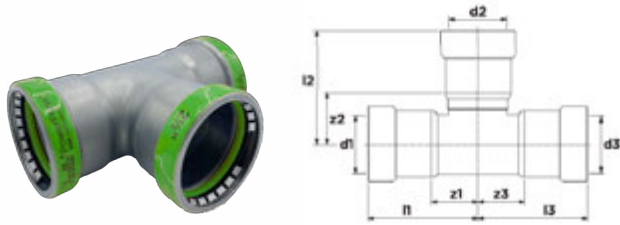

size	item no.	L1	L2	L3	Z1	Z2	Z3	weight [lb]
3" x 3" x 2½"	123461360	4.74	4.15	4.74	2.44	2.28	2.44	4.26
4" x 4" x 2½"	123461363	6.18	4.65	6.18	3.05	2.78	3.05	6.32
4" x 4" x 3"	123461364	6.18	5.20	6.18	3.05	2.89	3.05	6.73

size	item no.	D1	d1	D2	d2	D3	d3	weight [lb]
3" x 3" x 2½"	123461360	4.17	3.56	3.54	2.93	4.17	3.56	4.26
4" x 4" x 2½"	123461363	5.20	4.58	3.54	2.93	5.20	4.58	6.32
4" x 4" x 3"	123461364	5.20	4.58	4.17	3.56	5.20	4.58	6.73

**411-LD tee EPDM**  
(press x press x press)

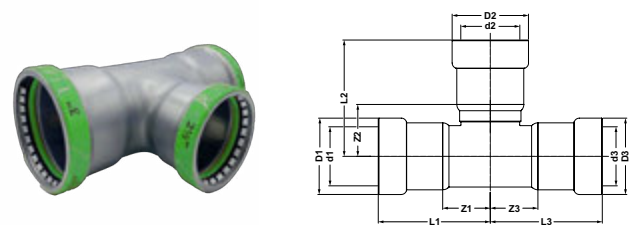

size	item no.	L1	L2	L3	Z1	Z2	Z3	weight [lb]
2½"	123461365	3.90	3.90	3.90	2.03	2.03	2.03	3.37
3"	123461366	4.74	4.74	4.74	2.44	2.44	2.44	4.80
4"	123461367	6.18	6.18	6.18	3.05	3.05	3.05	7.99

size	item no.	D1	d1	D2	d2	D3	d3	weight [lb]
2½"	123461365	3.54	2.93	3.54	2.93	3.54	2.93	3.37
3"	123461366	4.17	3.56	4.17	3.56	4.17	3.56	4.80
4"	123461367	5.20	4.58	5.20	4.58	5.20	4.58	7.99



"Apollo"® PowerPress®

# HNBR fittings & valves



**89FVH** gas ball valve HNBR  
(press x press)



**description**

the “Apollo”® PowerPress® 89FV ball valve is ideal for installation in compressed air and fuel gas applications. This valve design significantly reduces installation time and helps maintain a clean working environment. the “Apollo”® PowerPress® is designed for steel pipe, schedules 10 to 40, as defined by ASTM A53, A106, A135 and A795 standards.

**standard materials list**

component	material
body	carbon steel (ASTM A216-WCB)
seat	reinforced PTFE
ball	stainless steel (ASTM A276-316)
stem packing	multi-fill PTFE
nut	corrosion resistant plated steel
stem	stainless steel (ASTM A276-316)
retainer	carbon steel (ASTM A108-12L14)
sealing element	HNBR
handle	plated steel / insulated polyvinyl
gland	carbon steel (ASTM A108-1215)
stem bearing	reinforced PTFE
body seal	PTFE

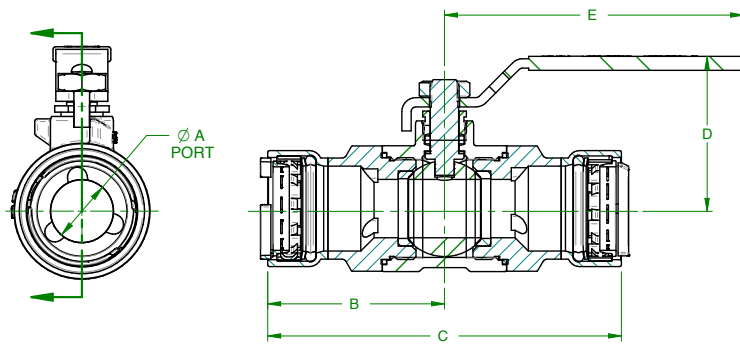

**dimensions**

size	item no.	weight [lb]	a	b	c	d	e
½"	89FVH4301	0.60	0.50	2.08	4.16	1.74	3.85
¾"	89FVH4401	0.90	0.75	2.28	4.55	1.96	3.85
1"	89FVH4501	1.40	1.00	2.72	5.44	2.29	4.76
1¼"	89FVH4601	4.20	1.25	3.41	6.82	3.20	7.76
1½"	89FVH4701	4.80	1.50	3.62	7.24	3.30	7.76
2"	89FVH4801	7.20	2.00	3.93	7.85	3.68	7.76

**specifications**

- patented visual control ring (yellow)
- HNBR sealing element
- full-port flow
- adjustable stem packing
- fast, reliable, economical press installation
- Ridgid® & milwaukee press tool compatible
- leak before press® technology
- blowout-proof stem
- corrosion resistant materials
- 100% factory tested
- silicone free assembly
- made in USA, ARRA compliant

max. operating pressure	operating temperature
125 psi for fuel applications	-40°F to -194°F
200 psi other applications	

**options**

(-01)	standard (PTFE packing, RPTFE body seal)
(-02)	grounded stem
(-24)	graphite stem packing
(-49)	assembled dry
(-60)	grounded ball & stem

**approved applications**

- compressed air
- fuel gas

**approvals & listings**

- ANSI LC4/CSA 6.32
- IAPMO LC 4
- CRN #0C10908 ADD11

**compliant with**

- uniform plumbing code (UPC)
- international plumbing code (IPC)
- international fuel gas code (IFGC)
- national plumbing code of canada

**400G coupling HNBR**  
(2 x press)

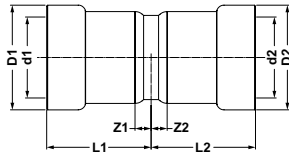

size	item no.	l1/l2	z1/z2	weight [lb]
1/2"	PWR7481298	1.34	0.24	0.29
3/4"	PWR7481309	1.46	0.24	0.38
1"	PWR7481311	1.65	0.23	0.48
1 1/4"	PWR7481320	2.19	0.30	0.95
1 1/2"	PWR7481331	2.26	0.33	1.20
2"	PWR7481342	2.38	0.30	1.58

**401G coupling - no stop HNBR**  
(2 x press)

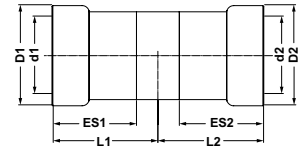

size	item no.	l1/l2	es1/es2	weight [lb]
1/2"	PWR7481353	1.55	1.10	0.32
3/4"	PWR7481364	1.64	1.22	0.41
1"	PWR7481375	1.84	1.42	0.62
1 1/4"	PWR7481386	2.34	1.89	0.95
1 1/2"	PWR7481397	2.50	1.93	1.29
2"	PWR7481408	2.56	2.09	1.68

**401RG coupling - reducing HNBR**  
(2 x press)

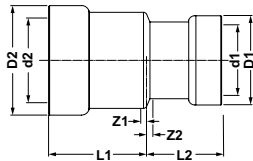

size	item no.	l1	l2	z1	z2	weight [lb]
3/4" x 1/2"	PWR7483168	1.33	1.14	0.11	0.04	0.29
1" x 1/2"	PWR7483179	1.61	1.13	0.19	0.03	0.32
1" x 3/4"	PWR7483181	1.55	1.24	0.13	0.02	0.07
1 1/4" x 3/4"	PWR7483190	2.15	1.24	0.26	0.02	0.63
1 1/4" x 1"	PWR7483201	2.07	1.43	0.18	0.01	0.60
1 1/2" x 1 1/4"	PWR7483212	2.09	1.95	0.16	0.06	0.80
2" x 1 1/4"	PWR7483223	2.39	1.95	0.31	0.06	0.98
2" x 1 1/2"	PWR7483234	2.33	2.00	0.24	0.07	1.22

**403G adapter - female HNBR**  
(press x FPT)

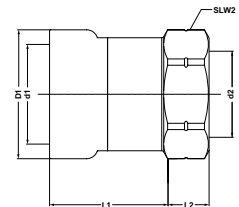

size	item no.	l1	l2	z1	z2	slw2	weight [lb]
1/2" x FPT 1/2"	PWR7482145	1.26	0.57	0.16	0.00	1.10	0.23
3/4" x FPT 1/2"	PWR7482156	1.32	0.63	0.10	0.06	1.42	0.36
3/4" x FPT 3/4"	PWR7482167	1.30	0.63	0.08	0.00	1.42	0.33
1" x FPT 1/2"	PWR7482178	1.52	0.71	0.10	0.06	1.61	0.60
1" x FPT 3/4"	PWR7482189	1.48	0.71	0.06	0.06	1.61	0.53
1" x FPT 1"	PWR7482191	1.56	0.71	0.14	0.00	1.61	0.43
1 1/4" x FPT 1/2"	PWR7482200	2.05	0.79	0.16	0.16	1.97	1.07
1 1/4" x FPT 3/4"	PWR7482211	2.11	0.69	0.22	0.06	1.97	0.99
1 1/4" x FPT 1"	PWR7482222	2.07	0.79	0.18	0.04	1.97	0.73
1 1/4" x FPT 1 1/4"	PWR7482233	1.97	0.83	0.08	0.00	1.97	0.74
1 1/2" x FPT 1/2"	PWR7482244	2.09	0.85	0.16	0.22	2.24	1.44
1 1/2" x FPT 3/4"	PWR7482255	2.11	0.79	0.18	0.16	2.24	1.35
1 1/2" x FPT 1"	PWR7482266	2.17	0.79	0.24	0.04	2.24	1.32
1 1/2" x FPT 1 1/4"	PWR7482277	2.09	0.79	0.16	0.02	2.24	1.08
1 1/2" x FPT 1 1/2"	PWR7482288	2.01	0.81	0.08	0.04	2.24	0.91
2" x FPT 1/2"	PWR7482299	2.46	0.79	0.37	0.18	2.76	1.75
2" x FPT 3/4"	PWR7482301	2.46	0.79	0.37	0.16	2.76	1.98
2" x FPT 1"	PWR7482310	2.46	0.79	0.37	0.04	2.76	1.23
2" x FPT 1 1/4"	PWR7482321	2.46	0.79	0.37	0.02	2.76	1.69
2" x FPT 1 1/2"	PWR7482332	2.32	0.79	0.24	0.02	2.76	1.65
2" x FPT 2"	PWR7482343	2.22	0.79	0.14	0.00	2.76	1.21

### 404G adapter - male HNBR

(press x MPT)

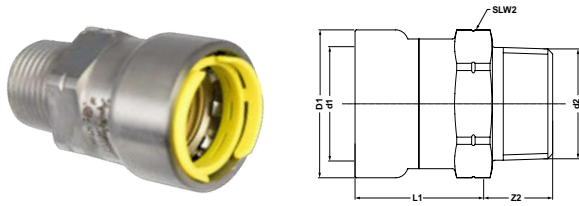

size	item no.	l1	l2	slw2	weight [lb]
½" x MPT ½"	PWR7482081	1.38	0.61	1.10	0.22
¾" x MPT ¾"	PWR7482090	1.40	0.63	1.42	0.31
1" x MPT 1"	PWR7482101	1.61	0.89	1.61	0.40
1¼" x MPT 1¼"	PWR7482112	2.12	0.77	1.97	0.75
1½" x MPT 1½"	PWR7482123	2.13	0.77	2.24	0.91
2" x MPT 2"	PWR7482134	2.33	0.78	2.76	1.23

### 406G 45° elbow HNBR

(2 x press)

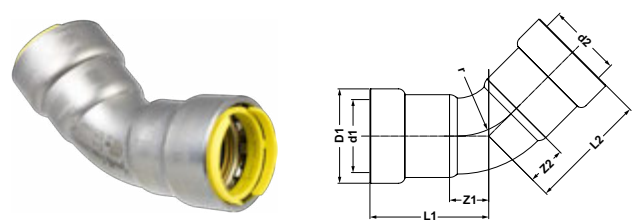

size	item no.	l1/l2	z1/z2	r	weight [lb]
½"	PWR7481531	1.59	0.49	0.98	0.33
¾"	PWR7481540	1.79	0.57	1.18	0.44
1"	PWR7481551	2.11	0.69	1.50	0.73
1¼"	PWR7481562	2.78	0.89	1.77	1.12
1½"	PWR7481573	2.91	0.98	1.97	1.48
2"	PWR7481584	3.29	1.20	2.56	2.06

### 406-2G 45° street elbow HNBR

(press x street Ø)

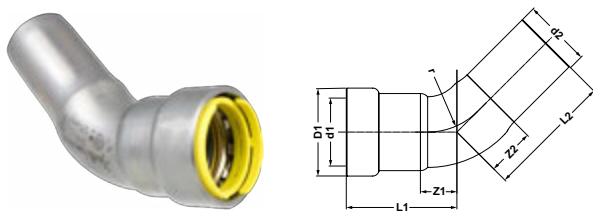

size	item no.	l1	l2	z1	r	weight [lb]
½"	PWR7481595	1.59	2.13	0.49	0.98	0.34
¾"	PWR7481606	1.81	2.26	0.59	1.18	0.45
1"	PWR7481617	2.13	2.68	0.71	1.50	0.71
1¼"	PWR7481628	2.78	3.24	0.89	1.77	1.01
1½"	PWR7481639	3.31	3.35	1.38	1.97	1.51
2"	PWR7481641	3.31	3.99	1.22	2.56	2.19

### 407G 90° elbow HNBR

(2 x press)

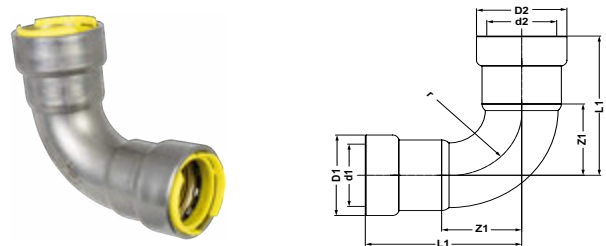

size	item no.	l1/l2	z1/z2	r	weight [lb]
½"	PWR7481419	2.17	1.06	0.98	0.40
¾"	PWR7481421	2.48	1.26	1.18	0.54
1"	PWR7481430	2.99	1.57	1.50	0.86
1¼"	PWR7481441	3.80	1.91	1.77	1.33
1½"	PWR7481452	4.06	2.13	1.97	1.80
2"	PWR7481463	4.78	2.70	2.56	2.64

**407-2G 90° street elbow HNBR**  
(2 x press)

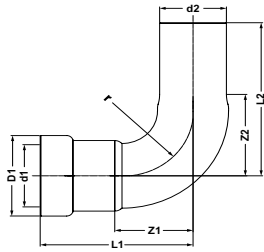

size	item no.	l1	l2	z1	r	weight [lb]
½"	PWR7481474	2.17	2.70	1.06	0.98	0.40
¾"	PWR7481485	2.48	2.95	1.26	1.18	0.54
1"	PWR7481496	2.99	3.56	1.57	1.50	0.89
1¼"	PWR7481507	3.80	4.27	1.91	1.77	1.36
1½"	PWR7481518	4.47	4.49	2.54	1.97	1.80
2"	PWR7481529	4.78	5.49	2.70	2.56	2.76

**411G tee HNBR**  
(3 x press)

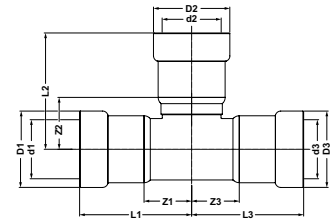

size	item no.	l1/l3	l2	z1/z3	z2	weight [lb]
½"	PWR7481650	2.05	2.09	0.94	0.98	0.57
¾"	PWR7481661	2.24	2.30	1.02	1.08	0.74
1"	PWR7481672	2.60	2.66	1.18	1.24	1.14
1¼"	PWR7481683	3.23	3.35	1.34	1.46	1.78
1½"	PWR7481694	3.48	3.50	1.56	1.57	2.36
2"	PWR7481705	3.78	3.92	1.69	1.83	3.17

**411RG tee reducing HNBR**  
(3 x press)

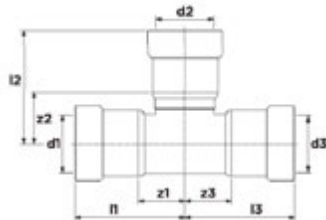

size	item no.	l1/l3	l2	z1/z3	z2	weight [lb]
¾" x ¾" x ½"	PWR7481716	2.24	2.19	1.02	1.08	0.70
1" x 1" x ½"	PWR7481727	2.60	2.34	1.18	1.24	1.00
1" x 1" x ¾"	PWR7481738	2.60	2.46	1.18	1.24	1.05
1¼" x 1¼" x ½"	PWR7483124	3.22	2.50	1.33	1.39	1.24
1¼" x 1¼" x ¾"	PWR7483135	3.22	2.60	1.33	1.38	1.51
1¼" x 1¼" x 1"	PWR7481749	3.23	2.81	1.34	1.40	1.61
1½" x 1½" x ½"	PWR7481751	3.48	2.58	1.56	1.48	1.91
1½" x 1½" x ¾"	PWR7481760	3.48	2.69	1.56	1.47	1.94
1½" x 1½" x 1"	PWR7481771	3.48	2.89	1.56	1.48	2.05
1½" x 1½" x 1¼"	PWR7481782	3.48	3.43	1.56	1.54	2.23
2" x 2" x ½"	PWR7481793	3.78	2.87	1.69	1.77	2.56
2" x 2" x ¾"	PWR7481804	3.78	2.99	1.69	1.77	2.62
2" x 2" x 1"	PWR7481815	3.78	3.19	1.69	1.77	2.72
2" x 2" x 1¼"	PWR7481826	3.78	3.72	1.69	1.83	2.90
2" x 2" x 1½"	PWR7481837	3.78	3.80	1.69	1.87	3.02

**4712G tee female HNBR**  
(press x press x FPT)

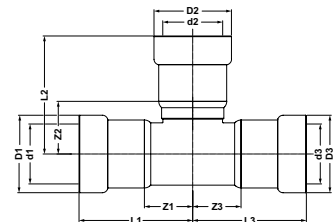

size	item no.	l1/l3	l2	z1/z3	z2	slw2	weight [lb]
¾" x ¾" x FPT ½"	PWR7481848	2.24	2.24	1.02	1.03	1.10	0.68
¾" x ¾" x FPT ¾"	PWR7481859	2.24	1.71	1.02	1.06	1.26	0.70
1" x 1" x FPT ½"	PWR7481861	2.60	1.81	1.18	1.19	1.10	0.98
1" x 1" x FPT ¾"	PWR7481870	2.60	1.87	1.18	1.22	1.26	0.91
1¼" x 1¼" x FPT ½"	PWR7481881	3.23	1.97	1.34	1.34	1.10	1.25
1¼" x 1¼" x FPT ¾"	PWR7483146	3.22	1.37	1.33	1.37	1.26	1.42
1¼" x 1¼" x FPT 1"	PWR7483157	3.22	2.17	1.33	1.40	1.61	1.40
1½" x 1½" x FPT ½"	PWR7481892	3.48	2.05	1.56	1.43	1.10	1.89
1½" x 1½" x FPT ¾"	PWR7481903	3.48	2.11	1.56	1.46	1.26	1.81
1½" x 1½" x FPT 1"	PWR7481914	3.48	2.26	1.56	1.49	1.61	2.04
1½" x 1½" x FPT 1¼"	PWR7481925	3.48	2.36	1.56	1.57	1.97	1.92
2" x 2" x FPT ½"	PWR7481936	3.78	2.34	1.69	1.72	1.10	2.53
2" x 2" x FPT ¾"	PWR7481947	3.78	2.40	1.69	1.75	1.26	2.58
2" x 2" x FPT 1"	PWR7481958	3.78	2.56	1.69	1.78	1.61	2.71
2" x 2" x FPT 1¼"	PWR7481969	3.78	2.66	1.69	1.87	1.97	2.80
2" x 2" x FPT 1½"	PWR7481971	3.78	2.66	1.69	1.87	2.36	3.05

**417G cap HNBR**  
(1 x press)

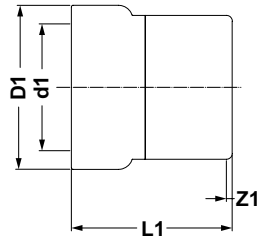

size	item no.	l1	z1	weight [lb]
½"	PWR7482475	1.38	0.28	0.17
¾"	PWR7482486	1.48	0.26	0.22
1"	PWR7482497	1.69	0.28	0.48
1¼"	PWR7482508	2.20	0.31	0.60
1½"	PWR7482519	2.24	0.31	0.75
2"	PWR7482521	2.44	0.35	0.99

**418G fitting reducer HNBR**  
(street Ø x press)

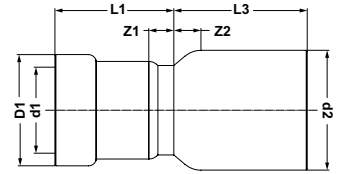

size	item no.	l1	l2	z2	weight [lb]
Ø ¾" x ½"	PWR7481980	1.37	1.15	0.04	0.30
Ø 1" x ½"	PWR7481991	1.56	1.15	0.04	0.40
Ø 1" x ¾"	PWR7482002	1.45	1.26	0.04	0.42
Ø 1¼" x 1"	PWR7482013	1.88	1.46	0.04	0.76
Ø 1½" x ¾"	PWR7482024	2.48	1.80	0.58	0.78
Ø 1½" x 1"	PWR7482035	1.94	1.46	0.04	0.86
Ø 1½" x 1¼"	PWR7482046	1.88	1.93	0.04	0.97
Ø 2" x 1"	PWR7482057	2.71	1.98	0.56	1.13
Ø 2" x 1¼"	PWR7482068	1.88	1.93	0.04	1.39
Ø 2" x 1½"	PWR7482079	1.95	1.97	0.04	1.34

**4733G union HNBR**  
(2 x press)

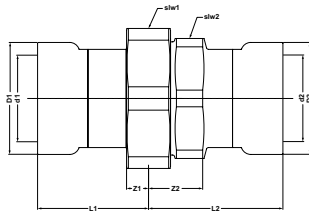

size	item no.	l1	l2	z1	z2	slw1	slw2	weight [lb]
½"	PWR7482354	1.74	2.04	0.65	0.94	1.61	1.42	0.49
¾"	PWR7482365	2.13	2.00	0.93	0.80	1.61	1.42	0.67
1"	PWR7482376	2.15	2.50	0.76	1.10	2.17	1.97	1.01
1¼"	PWR7482387	2.10	2.88	0.21	0.97	2.76	2.36	1.64
1½"	PWR7482398	2.97	2.85	1.04	0.92	2.76	2.36	2.23
2"	PWR7482409	3.31	3.31	1.21	1.21	3.35	2.95	2.90

**4734G union female HNBR**  
(press x FPT)

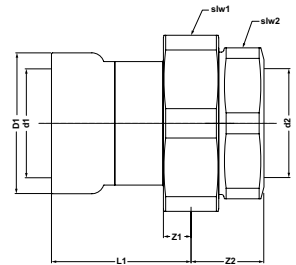

size	item no.	l1	l2	z1	z2	slw1	slw2	weight [lb]
½" x FPT ½"	PWR7483300	1.83	0.96	0.73	0.96	1.61	1.42	0.49
¾" x FPT ¾"	PWR7483311	2.22	0.91	1.00	0.91	1.61	1.42	0.67
1" x FPT 1"	PWR7483322	2.27	1.16	0.85	1.16	2.17	1.97	1.01
1¼" x FPT 1¼"	PWR7483333	2.22	1.23	0.33	1.23	2.76	2.36	1.64
1½" x FPT 1½"	PWR7483344	3.09	1.16	1.16	1.16	2.76	2.36	2.23
2" x FPT 2"	PWR7483355	3.46	1.41	1.37	1.41	3.35	2.95	3.37

**4771G flange adapter - class 150 HNBR**  
(press x flange)

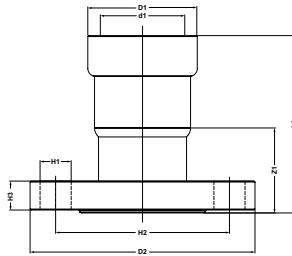

size	item no.	l1	z1	k2	b2	D2	d2-2	n2	weight [lb]
½"	PWR7482411	2.42	1.32	2.38	0.63	3.54	0.63	4	1.15
¾"	PWR7482420	2.62	1.40	3.25	0.63	3.94	0.63	4	1.63
1"	PWR7482431	2.93	1.52	3.13	0.63	4.33	0.63	4	2.24
1¼"	PWR7482442	3.56	1.67	3.50	0.63	4.53	0.63	4	2.82
1½"	PWR7482453	3.80	1.87	3.88	0.63	4.92	0.63	4	3.75
2"	PWR7482464	3.90	1.81	4.74	0.63	5.91	0.75	4	5.42





# "Apollo"® PowerPress®

## HNBR large diameter



**406G-LD 45° elbow HNBR**  
(press x press)

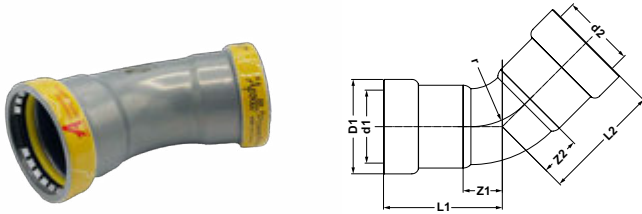

size	item no.	L1	L2	Z1	Z2	D1	d1	D2	d2	weight [lb]
2½"	123461052	3.92	3.92	2.05	2.05	3.54	2.93	3.54	2.93	2.48
3"	123461053	4.69	4.69	2.38	2.38	4.17	3.56	4.17	3.56	3.47
4"	123461054	6.14	6.14	3.01	3.01	5.20	4.58	5.20	4.58	5.69

**406-2G-LD 45° street elbow HNBR**  
(press x FTG)

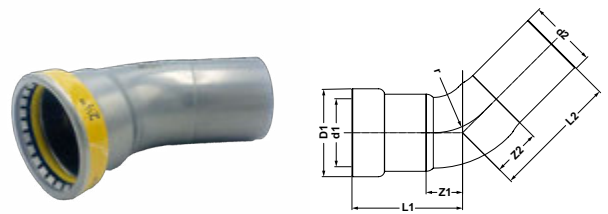

size	item no.	L1	L2	Z1	Z2	D1	d1	d2	weight [lb]
2½"	123461055	3.92	4.23	2.05		3.54	2.93	2.87	2.38
3"	123461056	4.69	4.57	2.38		4.17	3.56	3.50	3.26
4"	123461057	6.14	5.94	3.01		5.20	4.58	4.49	5.36

**407G-LD 90° elbow EPDM**  
(press x press)

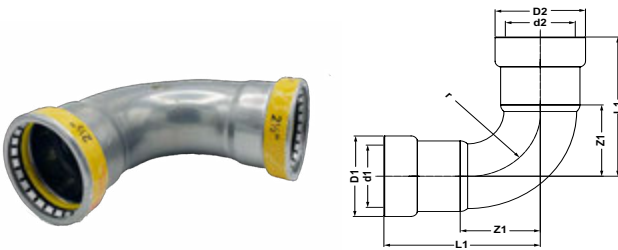

size	item no.	L1	L2	Z1	Z2	D1	d1	D2	d2	weight [lb]
2½"	123461058	5.98	5.98	4.11	4.11	3.54	2.93	3.54	2.93	3.31
3"	123461059	7.09	7.09	4.78	4.78	4.17	3.56	4.17	3.56	4.67
4"	123461060	9.25	9.25	6.12	6.12	5.20	4.58	5.20	4.58	7.60

**407-2G-LD 90° street elbow HNBR**  
(press x FPT)

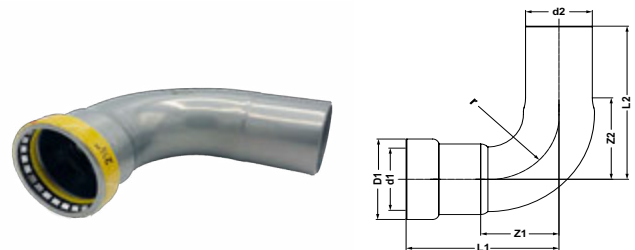

size	item no.	L1	L2	Z1	Z2	D1	d1	d2	weight [lb]
2½"	123461061	5.98	5.98	4.11		3.54	2.93	2.87	3.24
3"	123461062	7.09	6.97	4.78		4.17	3.56	3.50	4.42
4"	123461063	9.25	9.06	6.12		5.20	4.58	4.49	7.18

**403G-LD adapter-female HNBR**  
(press x FTG)

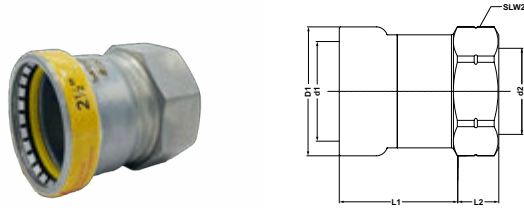

size	item no.	L1	Z2	D1	d1	d2	SLW2	weight [lb]
2½"	123461064			3.54	2.93	2.88		1.83
3"	123461065			4.17	3.56	3.50		2.35
4"	123461066			5.20	4.58	4.50		3.35

**404G-LD adapter-male HNBR**  
(press x MPT)

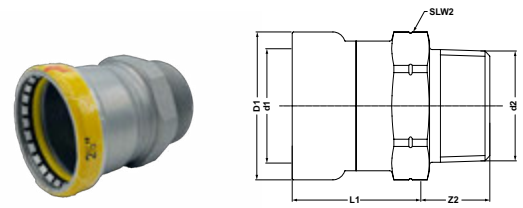

size	item no.	L1	Z2	D1	d1	d2	SLW2	weight [lb]
2½"	123461067			3.54	2.93	2.88		1.72
3"	123461068			4.17	3.56	3.50		2.34
4"	123461069			5.20	4.58	4.50		4.12

**417G-LD cap HNBR**  
(press)

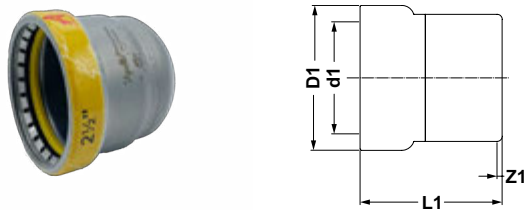

size	item no.	L1	Z1	D1	d1	weight [lb]
2½"	123461070	3.60	1.73	3.54	2.93	1.30
3"	123461071	4.21	1.91	4.17	3.56	1.70
4"	123461072	5.39	2.26	5.20	4.58	2.70

**401G-LD coupling - no stop HNBR**  
(press x press)

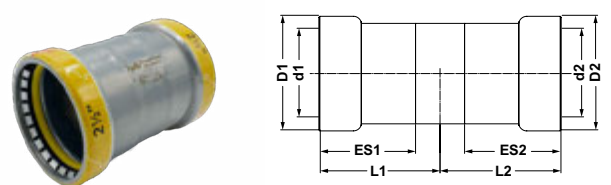

size	item no.	L1	L2	ES1	ES2	D1	d1	D2	d2	weight [lb]
2½"	123461073	2.46	2.46	1.87	1.87	3.54	2.93	3.54	2.93	1.73
3"	123461074	2.99	2.99	2.30	2.30	4.17	3.56	4.17	3.56	2.41
4"	123461075	3.94	3.94	3.13	3.13	5.20	4.58	5.20	4.58	4.01

**400G-LD coupling HNBR**  
(press x press)

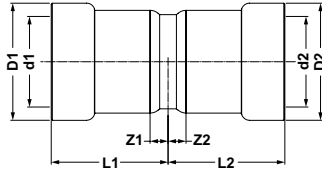

size	item no.	L1	L2	Z1	Z2	D1	d1	D2	d2	weight [lb]
2½"	123461076	2.46	2.46	0.59	0.59	3.54	2.93	3.54	2.93	1.73
3"	123461077	2.99	2.99	0.69	0.69	4.17	3.56	4.17	3.56	2.43
4"	123461078	3.94	3.94	0.81	0.81	5.20	4.58	5.20	4.58	3.96

**418G-LD fitting reducer HNBR**  
(FTG x press)

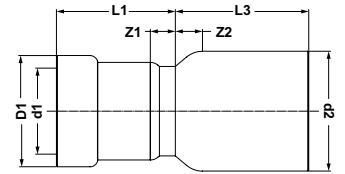

size	item no.	L1	L2	Z1	Z2	D1	d1	d2	weight [lb]
2½" x 1"	123461079	3.44	1.38			1.78	1.36	2.87	1.18
2½" x 1¼"	123461081	3.37	1.82			2.20	1.71	2.87	1.30
2½" x 1½"	123461080	3.30	1.87			2.44	1.95	2.87	1.41
2½" x 2"	123461082	3.13	1.95			2.89	2.42	2.87	1.49
3" x 1¼"	123461084	4.12	1.83			2.20	1.71	3.50	1.77
3" x 1½"	123461083	4.07	1.88			2.44	1.95	3.50	1.88
3" x 2"	123461085	4.26	1.96			2.89	2.42	3.50	1.66
3" x 2½"	123461086	3.81	1.90			3.54	2.93	3.50	1.95
4" x 1½"	123461087	5.56	1.88			2.44	1.95	4.49	3.07
4" x 2"	123461088	5.40	1.96			2.89	2.42	4.49	3.11
4" x 2½"	123461089	5.15	1.90			3.54	2.93	4.49	3.04
4" x 3"	123461090	5.03	2.33			4.17	3.56	4.49	3.26

**4771G-LD flange adapter (class 150) HNBR**  
(press x FLG)

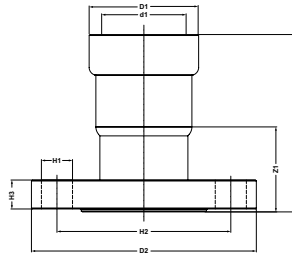

size	item no.	L1	Z1	D1	d1	D2	H1	H2	H3	weight [lb]
2½"	123461091	3.12	1.25	3.54	2.93	7.01	0.75	5.51	0.88	8.43
3"	123461092	3.78	1.48	4.17	3.56	7.48	0.75	6.00	0.94	9.88
4"	123461093	4.72	1.59	5.20	4.58	9.02	0.75	7.50	0.94	13.87

**4712G-LD tee-female HNBR**  
(press x press x FTG)

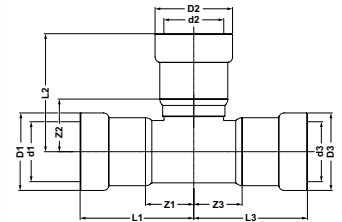

size	item no.	L1	L2	L3	Z1	Z2	Z3	weight [lb]
2½"	123461094	3.15	1.40	3.15	1.28		1.28	2.24
3"	123461095	3.74	1.53	3.74	1.44		1.44	3.10
4"	123461096	4.72	1.77	4.72	1.59		1.59	4.50

size	item no.	D1	d1	d2	D3	d3	slw2	weight [lb]
2½"	123461094	3.54	2.93	1.05	3.54	2.93	1.26	2.24
3"	123461095	4.17	3.56	1.05	4.17	3.56	1.26	3.10
4"	123461096	5.20	4.58	1.05	5.20	4.58	1.26	4.50

**411RG-LD tee-reducing HNBR**  
(press x press x press)

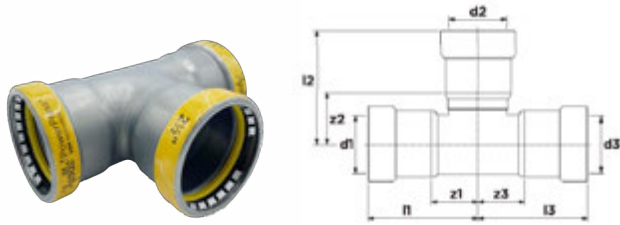

size	item no.	L1	L2	L3	Z1	Z2	Z3	weight [lb]
3" x 3" x 2½"	123461104	4.74	4.15	4.74	2.44	2.28	2.44	4.26
4" x 4" x 2½"	123461107	6.18	4.65	6.18	3.05	2.78	3.05	6.32
4" x 4" x 3"	123461108	6.18	5.20	6.18	3.05	2.89	3.05	6.73

size	item no.	D1	d1	D2	d2	D3	d3	weight [lb]
3" x 3" x 2½"	123461104	4.17	3.56	3.54	2.93	4.17	3.56	4.26
4" x 4" x 2½"	123461107	5.20	4.58	3.54	2.93	5.20	4.58	6.32
4" x 4" x 3"	123461108	5.20	4.58	4.17	3.56	5.20	4.58	6.73

**411G-LD tee HNBR**  
(press x press x press)

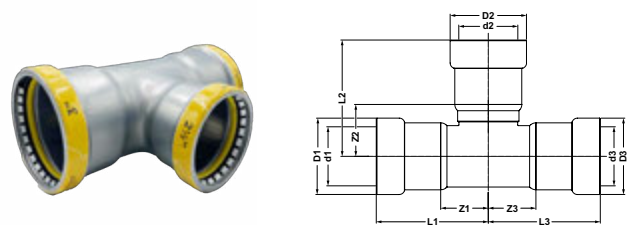

size	item no.	L1	L2	L3	Z1	Z2	Z3	weight [lb]
2½"	123461109	3.90	3.90	3.90	2.03	2.03	2.03	3.37
3"	123461110	4.74	4.74	4.74	2.44	2.44	2.44	4.80
4"	123461111	6.18	6.18	6.18	3.05	3.05	3.05	7.99

size	item no.	D1	d1	D2	d2	D3	d3	weight [lb]
2½"	123461109	3.54	2.93	3.54	2.93	3.54	2.93	3.37
3"	123461110	4.17	3.56	4.17	3.56	4.17	3.56	4.80
4"	123461111	5.20	4.58	5.20	4.58	5.20	4.58	7.99

# terms & conditions

**SCOPE AND ENTIRE AGREEMENT:** THESE TERMS AND CONDITIONS OF SALE (“TERMS AND CONDITIONS”) APPLY TO THE PURCHASE OF GOODS BY BUYER (TOGETHER WITH ITS SUCCESSORS, HEIRS, AFFILIATES, subsidiaries, and permitted assigns collectively, “Buyer”) from Aalberts integrated piping systems Americas, Inc. (“Seller” or “AIPSA”). In the event a written agreement for the supply of goods is executed by authorized representatives of both Buyer and Seller (“Supply Agreement”), such Supply Agreement shall supersede these Terms and Conditions to the extent of any conflict. Except as otherwise agreed to in a Supply Agreement, these Terms and Conditions, as well as the terms and conditions printed on the face of Seller’s order acknowledgement and invoice, constitute the sole and entire agreement between Buyer and Seller with respect to the subject matter hereof (“Agreement”) and supersede all prior oral and written agreements and understandings, whether express or implied, including those implied by law, through usage of trade, course of performance, or course of dealing. By placing an order or otherwise requesting purchase from Seller, Buyer shall be deemed to have agreed to these Terms and Conditions. Any term or condition included by Buyer which is inconsistent with, or in addition to, this Agreement is expressly rejected. Any attempted modification of this Agreement by Buyer, and any additional or different terms included in Buyer’s purchase order, other document submitted by Buyer to Seller, or Buyer’s internet site, shall be deemed a material alteration and not a rejection of these Terms and Conditions or Agreement and are hereby rejected by Seller, even if such purchase order or other document is accepted by Seller. This Agreement shall govern, control, and apply to all goods ordered by Buyer from Seller via purchase orders, delivery tickets, invoices or electronic commercial transactions between Buyer and Seller.

**ORDER ACCEPTANCE:** All orders for goods are subject to acceptance by Seller. Seller may withdraw goods from sale at any time without notice to Buyer. Orders that do not conform to Seller’s then-current volume or pricing policies shall be considered rejected without further notice to Buyer required. In the event of shortage of the goods, Seller may allocate available goods among customers as and how Seller sees fit.

**MINIMUM ORDER QUANTITY:** Seller, at its sole election, may establish reasonable minimum order quantities for goods with non-standard requirements for production such as special materials, special machine set ups, etc. Buyer will be notified at the time of quotation or when a Buyer submits a purchase order if the goods are subject to a minimum order quantity. If a submitted purchase order does not meet any established minimum order quantity, Seller expressly rejects the purchase order.

**PRICES AND PAYMENT TERMS:**

Prices for the goods shall be the prices stated in Seller’s price list in effect at the time of shipment, which prices may take into account increase in, inter alia, raw material costs that may occur during the between the acceptance of a Buyer’s order and shipment, unless otherwise agreed to in writing by Seller (e.g., as in Seller’s order acknowledgement). Certain cuts, modifications, sizing, specifications may be subject to upcharges, and list prices do not include related services (any tagging, testing, drawings, etc.) that may result in additional charges. Prices exclude all taxes, fees, and duties, including, without limitation, (a) all sales, use, franchise, license, excise, value-added, or other taxes; (b) export or import duties; and (c) inspection fees, all of which shall be paid by Buyer. All prices are subject to change by Seller at any time without notice. Price sheets are not offers to sell.

Time of payment is of the essence. Payment terms are net thirty days from date of invoice, unless otherwise agreed in writing by Seller. Buyer agrees to pay for all goods received by Buyer in full, without offset or deduction, at the prices, for the quantities, and per the payment terms specified on Seller’s invoice, by check or wire transfer of immediately available funds in the currency specified on Seller’s invoice and as reasonably directed by Seller. Buyer shall notify Seller of any dispute with respect to any invoice within ten (10) days of receipt of the disputed invoice or Buyer waives its right to dispute such invoice. Seller reserves the right to charge a late fee of one- and one-half percent (1½%) per month or the maximum percentage rate permitted by law, whichever is lower, on any amounts not paid in accordance with invoiced terms. Without limiting any other remedies under the law, Buyer shall reimburse Seller for all of Seller’s costs and expenses, including reasonable attorneys’ fees, incurred in connection with collecting payments due or otherwise enforcing this Agreement.

**FREIGHT ALLOWANCE:** FREIGHT ALLOWANCE: All combined material shipments are full freight allowed at \$6,000, excepting press products, including “Apollo” PowerPress, “Apollo” Press and “Apollo” SmartPress, which are full freight allowed at \$3,000. No freight will be allowed for Air Freight, Air Express, Parcel Post, U.P.S. shipments, other expedited shipping, or shipping in a manner that is not customary for Seller.

**SHIPPING & DELIVERY; TRANSFER OF TITLE AND RISK OF LOSS:**

Any orders that qualify for a freight allowance will be shipped F.O.B. Shipping Point, freight prepaid and allowed or as otherwise agreed to in writing by Seller. Any orders that do not qualify for a freight allowance will be shipped F.O.B. Shipping Point, freight prepaid and added to the invoice. For all orders, Seller reserves the right to select the carrier and method of shipment and to route shipments at Seller’s discretion. If Buyer requests shipment in a manner other than as selected by Seller, Buyer shall reimburse Seller for extra freight charges, special packaging, and incidental costs incurred for goods shipped at Buyer’s request by means other than Seller’s customary shipping methods. If Buyer requests Seller to delay shipping all or any portion of an order beyond its scheduled shipment date, Seller may at its discretion agree to delay shipment and impose a service charge of \$150 per pallet per day.

Title and risk of loss passes to Buyer upon delivery of goods by Seller to the carrier at the point of origin. Claims for damages or shortages in transit are the responsibility of Buyer. All shipping dates are approximate and are dependent upon prompt receipt from Buyer of all information necessary for the proper execution of Buyer’s purchase order and subject to Seller’s acceptance and confirmation. For items requiring export licensing, shipping dates are subject to receipt from the Buyer of requisite items as well as processing time for submission and approval of license. Goods controlled by or subject to the U.S. Bureau of Industry and Security or similar governmental oversight are placed on hold until export documents are obtained. Subject to their availability and requisite licensing, Seller will use commercially reasonable efforts to deliver the goods timely, but in no event will Seller be liable for any costs, charges, expenses, or damages (including liquidated damages), or for any penalty for late or delayed delivery. The time of delivery is not of the essence. Seller may, in its sole discretion and without liability or penalty, make partial shipments of goods to Buyer and each such partial shipment shall constitute a separate sale.

**TERMINATION OR SUSPENSION:** This Agreement and all shipments of goods shall, at all times, be subject to the approval by Seller of Buyer’s financial condition. Seller may extend credit to Buyer in Seller’s sole discretion and may modify such credit terms at any time. If the financial condition of Buyer at any time becomes unsatisfactory to Seller, in Seller’s sole discretion, or if Buyer fails to make payment when payment is due, fails to take delivery, or breaches this Agreement, in addition to any rights Seller may have, Seller may defer or decline to make any shipment(s), cancel a sale, or condition shipment(s) upon receipt of satisfactory security or cash in advance.

**INSPECTION BY BUYER AND NONCONFORMING GOODS:** All goods must be inspected by Buyer upon receipt. In the event the goods delivered do not conform to the product or quantity stated on a purchase order accepted by Seller pursuant to Seller’s order acknowledgement (“Nonconforming Goods”), Buyer must notify Seller in writing within ten (10) days after Buyer’s receipt of such Nonconforming Goods. A failure of Buyer to so notify Seller shall constitute a waiver of such a claim. Upon being notified by Buyer, Seller will be afforded a reasonable opportunity to investigate the claim and to correct the non-conformance by, in Seller’s sole discretion, either (a) replacing such Nonconforming Goods; or (b) crediting or refunding the price for such Nonconforming Goods, together with shipping charges incurred by Buyer in connection therewith. In either case, Buyer shall ship the nonconforming goods back to Seller at Seller’s reasonable direction and expense. The remedies set forth in this section are Buyer’s exclusive remedies with respect to the delivery of Nonconforming Goods. Seller will not have responsibility for paying for any costs associated with the use or installation of Nonconforming Goods. Buyer shall defend, indemnify and hold Seller harmless from any claim, damage, liability or expense (including but not limited to reasonable attorneys’ fees, costs of investigation, and costs of defense) arising out of or in connection with any violation of the preceding sentence. This section does not apply to nonconformities that are subject to an applicable End User or Reseller Limited Warranty, as defined below.

**NON-RETURNABLE, NON-CANCELLABLE GOODS:** The following goods are not returnable (“Non-Returnable Goods”): all non-stock, special, custom made, or modified items, including stock items that require special alloys or incorporation of special or non-standard materials, services, or requirements; items containing time-sensitive components that have reached the end of their warranty or shelf life; items that incorporate materials or components from a third party at request of Buyer; and clearance and limited-availability items. Orders (i) for Non-Returnable Goods or (ii) for any services already performed by Seller are non-cancellable and will be invoiced to Buyer for payment per these Terms and Conditions.

**RETURNS OF STANDARD, STOCK ITEMS:** Only standard, stock items that do not constitute Non-Returnable Goods (“Stock Items”) are subject to requests for return. Seller will not accept returns of broken boxes or returns of Stock Items less than case quantity. No goods may be returned without prior written authorization from Seller. Requests to return Stock Items must be made in writing within ninety (90) days from date of shipment by Seller. If authorized by Seller in writing, returns must be shipped prepaid by Buyer to the location designated on the return authorization. Credit will be issued based on the original invoice price, or price in effect at time of return, whichever is lower, less a minimum restocking charge of 30%. All returned goods must be in salable condition in order to qualify for credit. Return authorization will not be granted when the value of all items to be returned is less than \$6,500.00. Orders for Stock Items may be cancelled by notice to the Seller prior to shipment, subject to Buyer’s payment of a cancellation charge of 30% of the price in Seller’s order confirmation. Cancellation of any order after shipment will be subject to the return provisions of these Terms and Conditions.

**RESELLER LIMITED WARRANTY:**

Seller extends to (i) certain purchasers (e.g., builder, installer, contractor, or other person) purchasing the goods for use or installation, rather than resale, and (ii) end users (e.g., property owners) of goods it manufactures (collectively, "End Users") written limited warranties found at <https://aalberts-ips.us/warranty-information/> ("End User Limited Warranty"). If Buyer is an End User of the goods, the terms of the applicable End User Limited Warranty shall govern and control, and the remedies set forth in the End User Limited Warranty shall be Buyer's sole and exclusive remedy, and Seller's entire liability for any breach of warranty or other claim is controlled by the End User Limited Warranty.

It is understood and agreed that Buyer is not an End User. Seller warrants to Buyer that as of the date of manufacture, such goods materially conform to Seller's published specifications in effect as of the date of manufacture and are free from defects in material and workmanship that cause the goods to be unable to perform their intended function ("Reseller Limited Warranty"). Should any goods sold to Buyer in its capacity as a reseller of the goods be found to not meet the foregoing warranty, Seller shall, in its sole discretion, either furnish a replacement or make a fair allowance therefor; provided, however, that Buyer must provide Seller with a written notice of any claim under such warranty within thirty (30) calendar days of Buyer's receipt of the goods and must refrain from resale of the goods. Buyer must afford Seller a reasonable opportunity to inspect the goods and evaluate the claim. AS A RESELLER OF THE GOODS, THIS IS BUYER'S SOLE AND EXCLUSIVE REMEDY WITH RESPECT TO GOODS PURCHASED FOR RESALE WHICH DO NOT CONFORM TO THE WARRANTY STATED ABOVE, EXCEPT FOR THE RESELLER LIMITED WARRANTY, SELLER MAKES NO WARRANTY WHATSOEVER WITH RESPECT TO THE GOODS AND DISCLAIMS ALL OTHER WARRANTIES, INCLUDING ANY WARRANTY OF MERCHANTABILITY OR FITNESS FOR A PARTICULAR PURPOSE, WHETHER EXPRESS OR IMPLIED BY LAW, COURSE OF DEALING, COURSE OF PERFORMANCE, USAGE OF TRADE, OR OTHERWISE. Nothing in this Agreement or otherwise shall be construed so as to create or infer any other warranty on the goods.

**BUYER'S COMPLIANCE, RESELLER OBLIGATIONS, AND EXPORT CONTROL:**

Buyer shall comply with all applicable laws, rules, guidelines, regulations, and orders ("Laws") in any way relating to Buyer's purchase, ownership, transportation, receipt, handling, exportation, storage, processing, alteration, relabeling, refinishing, reconfiguring, rebranding, repackaging, disposal, redirection or resale of the goods once the goods have been received by Buyer, including all sanctions, anti-bribery, anti-money laundering and counter-terrorism financing laws applicable in its countries of establishment and/or operation.

In the event Buyer modifies, reconfigures, relabels, rebrands, or repackages the goods for resale (including further distribution), then (a) the goods shall be sold under Buyer's brand, (b) any warranty offer by Seller to Buyer shall be invalidated, and (c) Buyer shall be solely responsible for such modified, reconfigured, relabeled, rebranded, or repackaged goods and for ensuring such goods comply with all applicable Laws. Buyer acknowledges that the goods are subject to various federal, state, provincial, and local Laws and that the goods are labeled for end use within the jurisdiction in which the goods are delivered to Buyer.

Without limiting the foregoing, Buyer shall comply with, and at Seller's request shall demonstrate compliance with, all export laws, restrictions, and regulations of any U.S. agency or authority (including International Traffic in Arms Regulations (ITAR) or the Export Administration Regulations (EAR)) or foreign agency or authority. Buyer shall not export, or re-export, or allow the export or re-export of goods sold under this Agreement in violation of any such laws, embargoes, restrictions or regulations. The above also applies to the extent Buyer otherwise makes available to a foreign person (within or outside of the U.S.) the technical data, technology or know-how comprising, or relating to, the goods. Buyer shall obtain and bear all expenses relating to any necessary licenses and/or exemptions with respect to the export or re-export from the United States to Buyer or customers of Buyer in compliance with all applicable laws and regulations prior to shipment thereof. Buyer shall defend, indemnify and hold Seller harmless from any claim, damage, liability or expense (including but not limited to reasonable attorneys' fees, costs of investigation, and costs of defense) arising out of or in connection with any violation of the preceding sentence.

Buyer expressly acknowledges and agrees not to export, re-export or provide goods to any person, entity, or destination prohibited under U.S. Law from receiving such goods pursuant to sanction or otherwise, without obtaining prior government authorization. All warranties otherwise applicable to the goods shall be null and void for goods exported outside the U.S. and Canada and goods sold outside the U.S. and Canada are "as is", with no express or implied warranties provided by Seller.

**PRODUCT LITERATURE, SUITABILITY OF GOODS:** Buyer further agrees that it has received and will comply with available product literature on Seller's website as of the time of shipment relating to the transport, storage, handling, and installation of goods from Seller. Seller is not responsible for verifying if its goods are suitable for intended service conditions and assumes no responsibility for same.

**NO RECOVERY OF CONSEQUENTIAL OR SPECIAL DAMAGES:** IN NO EVENT WILL SELLER BE LIABLE FOR ANY INCIDENTAL, SPECIAL, MULTIPLE, PUNITIVE, INDIRECT, CONSEQUENTIAL, EXEMPLARY OR RESULTING DAMAGES, INCLUDING BUT NOT LIMITED TO, PROPERTY DAMAGE (INCLUDING WATER DAMAGE, MOLD, OR DAMAGE TO OTHER BUILDING COMPONENTS), LOST PROFITS OR REVENUES, OR LOSS OF USE WHETHER ARISING OUT OF BREACH OF CONTRACT, TORT, OR OTHERWISE, REGARDLESS OF WHETHER SUCH DAMAGES WERE FORESEEABLE AND WHETHER EITHER SELLER OR BUYER HAS BEEN ADVISED OF THE POSSIBILITY OF SUCH DAMAGES, AND NOTWITHSTANDING THE FAILURE OF ANY AGREED OR OTHER REMEDY OF ITS ESSENTIAL

**FORCE MAJEURE:** Seller shall not be liable, nor deemed in breach hereunder, for any failure or delay in delivering the goods or in the performance of its other obligations to Buyer hereunder, caused by or arising out of circumstances or events beyond the parties' control and that they could not reasonably avoid or overcome ("Force Majeure Event"). Force Majeure Events include, but are not limited to, strikes involving all or part of the Seller's personnel or its customary carriers, fire, flood, war (declared or not), riot, insurrection, acts of terrorism, pandemic, epidemic, public health emergency, acts (including, without limitation, suspensions, closures, and delays) of any governmental authority, priorities granted at the request or for the benefit, directly or indirectly, of any government or agency thereof, shortage of raw material, act of God, weather, natural disasters, production stoppages due to unintended breakdowns, impossibility of receiving supplies or raw materials, weight limits during thaw conditions, road blocks, strikes or breakdowns in electricity or utility supplies, or supply breakdowns attributable to Seller's suppliers, rebellion, revolution, insurrection, military or usurped power, civil war and other hostilities, invasion, act of foreign enemies, mobilization, requisition or embargo, ionizing radiation or contamination by radioactivity from any nuclear fuel or from any nuclear waste from the combustion of nuclear fuel, radioactive toxic explosives, or other hazardous properties of any explosive nuclear assembly or nuclear components thereof, and regardless of whether the cause or condition now exists or arises hereafter, and whether or not such condition is foreseeable. If Seller is rendered unable to carry out any or all of its obligations under this Agreement because of the happening of a Force Majeure Event, then Seller shall give notice to Buyer and, upon the giving of such notice, the obligations of Seller shall be suspended for as long as may be necessary under the circumstances. If the Force Majeure Event lasts longer than thirty (30) days from Seller's notice, Seller and Buyer both have the right to cancel each or all of Buyer's previously accepted and confirmed purchase orders by giving notice to the other within forty-five (45) days of the date of Seller's notice.

**INTELLECTUAL PROPERTY:** All intellectual property rights related to the goods are either the sole and exclusive property of Seller or Seller is an authorized licensee thereof. Buyer shall not receive any intellectual property ownership or licensing rights with respect to the intellectual property related to the goods. Buyer shall not analyze or otherwise examine, or allow to be analyzed or examined, any of Seller's goods for the purpose of reverse engineering the formulations for such goods. Buyer shall not modify, reconfigure, relabel, rebrand, or repackage the goods or remove any trademarks from or other markings on the goods without the express written consent of Seller.

**CONFIDENTIALITY:** Any nonpublic, confidential, or proprietary information disclosed by Seller to Buyer, regardless of whether or not such information is marked or identified as "confidential", including any special pricing, discounts, or rebates offered to Buyer, is confidential, solely for the use of performing this Agreement, and may not be disclosed by Buyer to any third party, except where required by law, unless authorized in advance by Seller in writing, where permitted by law. This section does not apply to information, other than personal information, that is in the public domain, known to Buyer at the time of disclosure, or rightfully obtained by Buyer on a non-confidential basis from a third party.

**SECURITY PLEDGE:** As collateral security for the payment of the purchase price of the goods, Buyer hereby grants to Seller a lien on and security interest in and to all of the right, title, and interest of Buyer in and to the goods until Buyer makes payment for the goods to Seller. The security interest granted under this provision constitutes a purchase-money security interest. Seller is expressly authorized, at its option, and as Buyer's attorney-in-fact, to file one or more financing statements or other notices under applicable law naming Buyer as debtor and Seller as secured party and indicating therein the goods and proceeds thereof as items of collateral. Without limiting the foregoing, Buyer further agrees to pledge each shipment of goods to Seller, and to execute such documents and to do such further acts as necessary to pledge such shipments to Seller.

**INDEMNIFICATION:** Buyer hereby indemnifies and agrees to defend and hold Seller harmless from any claims, damages, losses, costs and expenses including, without limitation, attorneys' fees and costs of investigation ("Loss") arising out of or related to (a) the negligent, reckless, or willful acts or omissions of Buyer (or its employees, contractors, or agents), (b) the breach by Buyer (or its employees, contractors, or agents) of its obligations, representations, or covenants hereunder, or (c) any failure by Buyer to comply with applicable Laws; provided, however, nothing contained herein obligates Buyer to indemnify and hold Seller harmless from Loss solely caused by (a) the negligent, reckless, or willful acts and omissions of Seller (or its employees, contractors, or agents), (b) the breach by Seller (or its employees, contractors, or agents) of its obligations, representations, or covenants hereunder, or (c) any failure by Seller to comply with applicable Laws.

GOVERNING LAW; CONSENT TO JURISDICTION: This Agreement and all matters arising out of or relating to this Agreement are governed and to be construed by the laws of the State of North Carolina, including specifically the provisions of the Uniform Commercial Code as then in effect in the State of North Carolina, without regard to any choice of law provisions that would obtain a different result. THE PARTIES EXPRESSLY EXCLUDE THE APPLICABILITY OF THE UNITED NATIONS CONVENTION ON CONTRACTS FOR THE INTERNATIONAL SALE OF GOODS. Any action or proceeding arising out of or related to this Agreement shall be brought only in a state court located in Mecklenburg County, North Carolina, or federal court for the Western District of North Carolina, and the parties hereby (i) consent to such exclusive venue and the exclusive jurisdiction of such courts over the subject matter of such proceeding and themselves and (ii) waive and agree not to assert defenses as to venue or personal jurisdiction in any action commenced in such courts pursuant to this Agreement.

ADDITIONAL TERMS:

This Agreement is for the sole benefit of Seller and Buyer, and nothing herein, express or implied, is intended to or shall confer upon any other person or entity any legal or equitable right, benefit, or remedy.

Buyer may not assign any rights nor delegate any obligations under this Agreement without Seller's prior written consent, and any attempt at assignment by Buyer is null and void. Failure of Seller to enforce any provision of these Terms and Conditions will not be construed as a waiver of any provision hereof. Any waiver must be made in writing, with reference to these Terms and Conditions specifically, and signed by Seller.

If any portion of this Agreement is held invalid or unenforceable, such portion shall be severed from the remaining parts and such holding will not affect the validity or enforceability of any other provision.

If (i) any quotation or other document of Seller is deemed to constitute an offer to Buyer or (ii) any purchase order or other document of Buyer is deemed to constitute an acceptance, Buyer's acceptance of Seller's offer is governed by and subject to these Terms and Conditions.

This Agreement does not obligate Buyer to order goods from Seller, nor does it obligate Seller to accept orders from Buyer.

Seller may amend or change these Terms and Conditions at any time without notice by posting an updated version thereof on its website. The version of these Terms and Conditions in effect as of the date OF SELLER'S ORDER ACKNOWLEDGMENT APPLIES AND SUPERSEDES ALL PRIOR VERSIONS.

more information?

---

For a complete and up-to-date product range and our additional services, visit: [aalberts-ips.us](http://aalberts-ips.us)

Would you like to make an appointment to meet an account manager in your region or receive advice and support from one of our experts?

Please contact:

**Aalberts integrated piping systems customer service**

**704.841.6000 (US)**

**905.851.9494 (CAN)**

