



# Charlemont™ | K-29259-BD1

24" bathroom vanity cabinet with sink and quartz top

## Features

- Set includes cabinet, precut quartz vanity top, backsplash, sink, cabinet hardware
- Convenient tilt-down drawer for storing smaller, frequently-used items
- Three-way adjustable soft-close door hinges for easy cabinet access
- 20" (508 mm) cabinet interior provides ample storage space
- Finish-matched cabinet interior offers generous clearance for plumbing
- Vanity top has 8" (203 mm) widespread faucet holes; requires deck-mount faucet (sold separately)
- Vibrant® Brushed Nickel hardware included on White, Umbral Green and Draper Oak vanities, Vibrant Brushed Moderne Brass hardware on Ferrous Grey and Tidal Blue vanities, and Matte Black hardware on Light Oak vanities
- White (GWT) quartz vanity top and backsplash add beauty and long-lasting durability
- Coordinates with White (GWT) quartz side splash (sold separately)



## Available Colors/Finishes

*Color tiles intended for reference only.*

- 0 White
- DWG Ferrous Grey
- TDB Tidal Blue
- WEK Light Oak
- DAK Draper Oak
- UMG Umbral Green



1-800-4KOHLER (1-800-456-4537)  
Kohler Co. reserves the right to make revisions without notice to product specifications.  
For the most current specification sheet, go to [www.kohler.com](http://www.kohler.com) USA or [www.kohler.ca](http://www.kohler.ca) Canada.  
5-30-2026 18:1 - US-CA

THE BOLD LOOK  
OF **KOHLER**

---

## Codes/Standards

ASME A112.19.2/CSA B45.1  
EPA TSCA Title VI/CARB P2

---

## Technical Information

*All product dimensions are nominal.*

Lighting Included:	No
Number of Deck Holes:	3
Center(s):	8" (203 mm)

---

## Material

- Vitreous china sink
  - Solid wood and moisture-resistant MDF
- 

## Recommended Products/Accessories

K-38554 4" x 21-11/16" quartz side splash

---

## Warranty

*See website for detailed warranty information.*

KOHLER® One-Year Limited Warranty



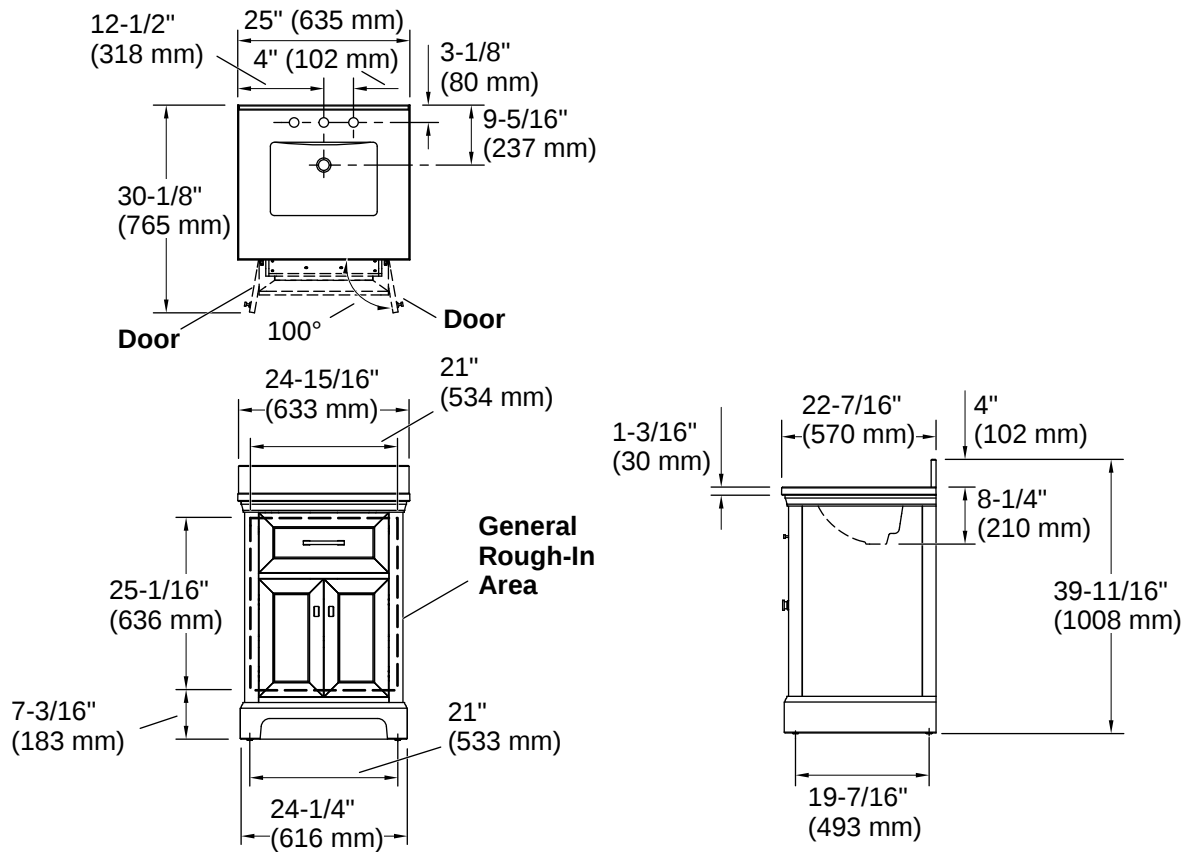

## Installation

- Separate vanity top makes for simplified installation
- Easy installation – no special tools required

## Installation Notes

*Install this product according to the installation instructions.*

Select the type of fastener based upon the wall material. Two 250 lb (113.4 kg) minimum load bearing fasteners are recommended.

