

Aquifer® | K-T30924

4-in-1 tall arc beverage faucet

Features

- High-arch swing spout with 160° rotation offers superior clearance for filling pitchers, chilling bottles, and cleanup
- 16-1/16" (408 mm) spout height
- Laminar flow
- Digital interface touchpad allows user to select between ambient, chilled, near-boiling, or sparkling water
- Digital interface can be mounted directly on counter surface or on escutcheon plate
- Box includes: Faucet, digital interface, escutcheon plate, supply lines
- Aquifer® 4-in-1 Grated Drain sold separately
- Requires K-34113 Aquifer® Beverage System (sold separately)



Sustainability



Available Colors/Finishes

Color tiles intended for reference only.

- CP Polished Chrome
- VS Vibrant Stainless
- BL Matte Black
- 2MB Vibrant Brushed Moderne Brass



Codes/Standards

ADA, CSA B651 compliant when installed to the specific requirements of these regulations.

ADA CSA B651

ASME A112.18.1/CSA B125.1
NSF/ANSI/CAN 372
NSF/ANSI/CAN 61
DOE - Energy Policy Act 1992
California Energy Commission (CEC)
ADA
ICC/ANSI A117.1
CSA B651

Technical Information

All product dimensions are nominal.

Spout

Spout Reach: 6-15/16" (176 mm)

Flow Rate

Faucet Flow Rate: 1 gpm (3.8 l/min)

Material

- Premium material construction for durability and reliability
 - KOHLER finishes resist corrosion and tarnishing
-

Recommended Products/Accessories

K-30928 Grated drain

Warranty

See website for detailed warranty information.

KOHLER® Electronic Faucets, Valves, and Controls Five-Year Limited Warranty



1-800-4KOHLER (1-800-456-4537)
Kohler Co. reserves the right to make revisions without notice to product specifications.
For the most current specification sheet, go to www.kohler.com USA or www.kohler.ca Canada.
5-8-2026 0:25 - US-CA

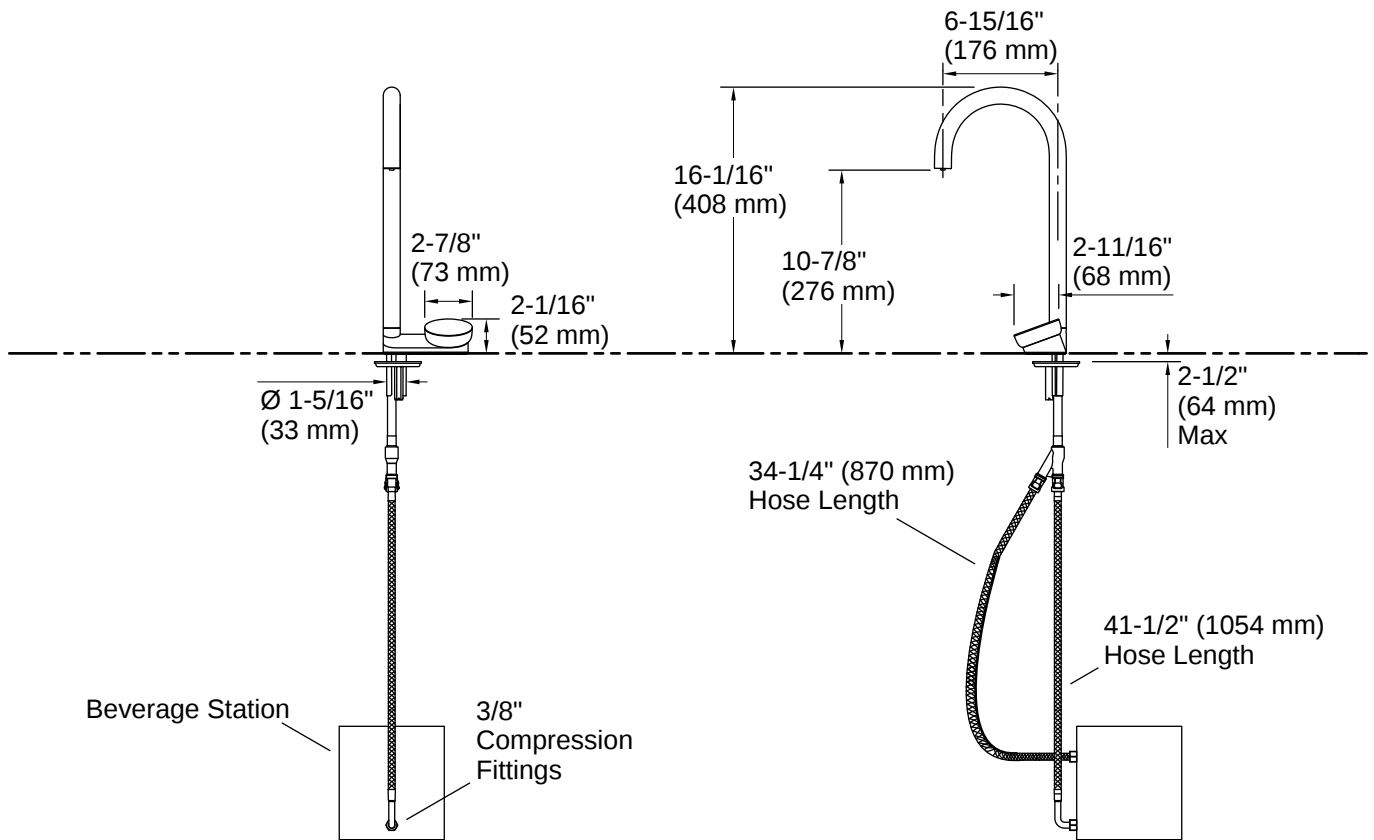

Installation

- Single- or two-hole installation
- Flexible supply lines simplify installation

Installation Notes

Install this product according to the installation instructions.

ADA, CSA B651 compliant when installed to the specific requirements of these regulations.

