



# WHOLE HOUSE AIR PURIFICATION SYSTEM

Models: TRIO-16, TRIO-20, TRIO-16HHS, TRIO-20HHS



## ITEMS INCLUDED:

- 1 - TRIO-16 or TRIO-20 Air Purification System
- 1 - 120V Quick Connect Power Cord
- 2 - UVC Germicidal Lamp
- 1 - Instruction Sheet
- 1 - Lens Label
- 1 - HHSC Control (only with HHS models)

TRIO Air Purification System installs into the return sided of ducted HVAC appliances. Most electronic and media air cleaners only capture particles. The TRIO electronic air purifier not only removes particles, but also reduces viruses, germs, and toxic gases.

This product is not sold as a medical device and is not for the purpose of diagnosis of any disease or condition, nor for use in the mitigation, treatment, or prevention of any disease or condition.

### READ THESE INSTRUCTIONS CAREFULLY AND COMPLETELY BEFORE PROCEEDING WITH THE INSTALLATION.



**WARNING: Do not exceed voltage rating. Severe damage to device and or fire could result. Verify proper voltage.**

This device **MUST** be installed by a qualified agency in accordance with the manufacturer's installation instructions. The definition of a qualified agency is: any individual, firm, corporation or company which either in person or through a representative is engaged in, and is responsible for, the installation and operation of HVAC appliances, who is experienced in such work, familiar with all the precautions required, and has complied with all the requirements of the authority having jurisdiction.

Please retain these instructions after installation.

Installed By: \_\_\_\_\_ Phone: \_\_\_\_\_ Installation Date: \_\_\_\_\_



**F I E L D C O N T R O L S**

www.fieldcontrols.com

P/N 780105101 02/21 Rev C

## SAFETY CONSIDERATIONS



**WARNING:** Never expose eyes or skin to UVC light from any source.

- Looking directly at the UVC light may cause permanent eye damage or blindness.
- Never operate the TRIO Air Purifying System out of the plenum.
- Designed for a closed duct system. Do not mount near a supply or a return air opening.
- All duct openings in direct line of site of the UV light must be sealed with aluminum tape or equivalent sealing methods.



**WARNING:** UV light will break down plastic materials not rated for UV exposure:

(Examples: wire insulation, flex duct, drain pans and humidifiers)

- The unit must be mounted at least 3" from the above stated type of materials.
- If it is necessary to mount the unit in direct line of site of these types of materials, they must be shielded with aluminum foil, aluminum foil tape, or sheet metal.



**WARNING:** DO NOT mount this unit outdoors.

- This product is designed for indoor installation only (i.e. attics, crawl spaces, basements, etc.).



**WARNING:** Never touch broken lamp or internal contents of lamp. The lamp contains mercury.

- After opening the carton, unpack and inspect the unit and lamp for damage. Do not install this unit if any damage is noticeable. If lamp is damaged, cracked or broken, do not touch lamp or other contents in carton. Close carton and return to seller immediately.
- In case of accidental exposure to internal contents of lamp, wash hands and any other affected skin area with mild detergent. Remove affected clothing immediately. If skin surface is pierced, seek medical attention immediately.

**NOTE:** If you touch the glass of the lamp, you should wipe the glass clean with isopropyl alcohol and a lint free wipe. If the lamp is not cleaned, the film of hand oils causes a reduction in the light intensity.



**WARNING:** Before installing or servicing a humidifier, air filter, HVAC system, or this unit, etc., always turn all power OFF and have unit unplugged. Electrical shock can cause personal injury or death. Never expose eyes or skin to direct UVC light from any source.



**WARNING:** To prevent water damage or electric shock, do not mount unit under a humidifier.



**WARNING:** This product is designed for indoor installation only (i.e. attics, crawl spaces, basements, etc.). For use on gas fired, oil fired, electric and split system heat pump forced air systems.\* This product is NOT designed to be mounted outside on gas fired or heat pump packaged units.\*\*

- \* Split system heat pumps are systems where the air handler and the air conditioning compressor are separate units.
- \*\* Packaged units are systems where the air handler and the air conditioning compressor are built together and are installed outside of the building.



**WARNING:** Never expose eyes or skin to UVC light from any source. Looking directly at the UVC light may cause permanent eye damage or blindness. Never operate the Trio Air Purifying System out of the ductwork. Avoid touching the glass portion of the lamp with your hands.

# SPECIFICATIONS

## Model TRIO-16:

(Capacity 1-1/2 to 3.0 tons)

Model: TRIO-16/TRIO-16HHS

Power: 120V/60 Hz .6 Amps 49.2 Watts

Fuse: Replace only with AGC-2 fuse

Application: 3 Ton Drive Air Handler / Furnace

Max Face Velocity: 500 FPM

Max Air Flow: 1200 CFM

Service: UVC Lamps - Best practice 1 year  
Filter – 6 to 12 months

U.V. Range: 254 NM (germicidal)

UVC Lamps: 16,000 Hours (2 year lamp life efficiency)  
Best Practice to replace every 12 months

## Model TRIO-20:

(Capacity 3.5 to 4.0 tons)

Model: TRIO-20/TRIO-20HHS

Power: 120V/60 Hz .6 Amps 49.2 Watts

Fuse: Replace only with AGC-2 fuse

Application: 4 Ton Drive Air Handler / Furnace

Max Face Velocity: 625 FPM

Max Air Flow: 1600 CFM

Service: UVC Lamps - Best practice 1 year  
Filter – 6 to 12 months

U.V. Range: 254 NM (germicidal)

UVC Lamps: 16,000 Hours (2 year lamp life efficiency)  
Best Practice to replace every 12 months

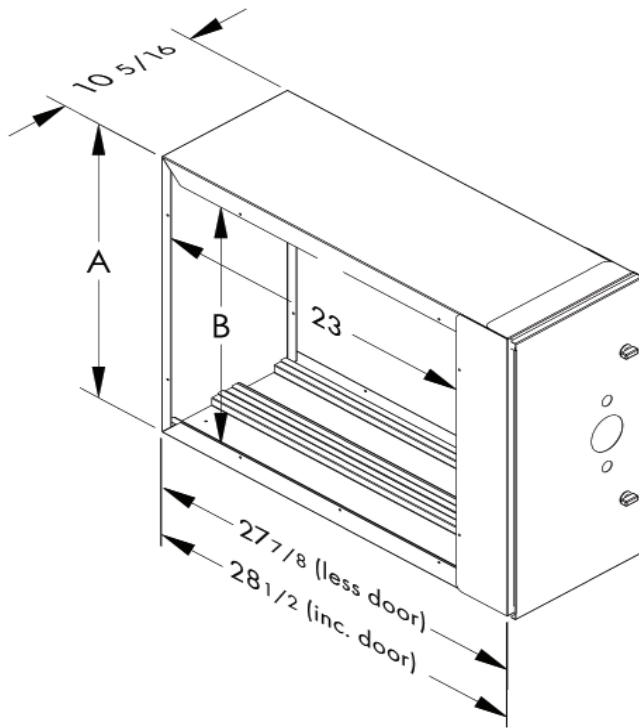

Model No	A	B
TRIO-16	17-1/8	14
TRIO-20	21-1/8	18

	Pressure Drop			
Model	600 CFM	800 CFM	1000 CFM	1200 CFM
TRIO-16	0.07	0.125	0.18	0.25
	Pressure Drop			
Model	1200 CFM	1400 CFM	1600 CFM	2000 CFM
TRIO-20	0.18	0.24	0.30	0.45



**WARNING:** Never expose eyes or skin to UVC light from any source. Looking directly at the UVC light may cause permanent eye damage or blindness. Never operate the Trio Air Purifying System out of the ductwork. Avoid touching the glass portion of the lamp with your hands.

## OPERATION

The TRIO Electronic Air Purifier installs in the air-inlet side of any heating and air conditioning system. Only operation of the air-handler fan unit is required for air purification and sterilization to take place.

NOTE: The UVC germicidal lamps are wired to operate continuously. This feature allows the catalyst to burn off surface impurities, cleaning and reactivating itself during periods of non-use or no airflow.

The TRIO Air Purification System combines three unique technologies to protect people against indoor air pollutants. PRO-Cell™ technology combined with high efficiency Nano-carbon MERV13 particulate filter and UVC germicidal light that quickly reduces and eliminates toxic gas-phase chemicals and lung damaging dust and air-borne germs from the living environment.

Many new homes have smart programmable thermostats that allow for automatic operation of the air-handler fan unit when there is no demand for heating or air conditioning. It is important that the TRIO Air Purification System is operating a minimum 20-30 minutes per hour (24) hours per day to remove airborne contaminants from the indoor environment. Best practice for optimum performance is to operate Heating & cooling system fan at constant on.

# TRIO

ELECTRONIC AIR PURIFIER

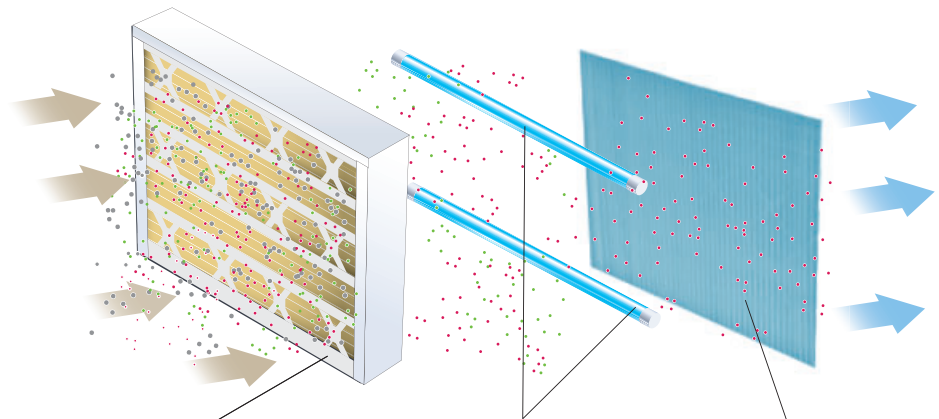

### THREE STAGE PROCESS

- 1** MERV 13 Nano-Carbon High Efficiency Filtration  
Traps particles including mold, bacteria, dust, dander, and pollen
- 2** UVC Germicidal Purification  
Reduces bacteria, viruses, mold, and fungi
- 3** Patented PRO-Cell™ Technology  
Dramatically reduces toxic VOCs and odors



**WARNING:** Never expose eyes or skin to UVC light from any source. Looking directly at the UVC light may cause permanent eye damage or blindness. Never operate the Trio Air Purifying System out of the ductwork. Avoid touching the glass portion of the lamp with your hands.

## REMOVING & REPLACING THE DOOR

To remove the door to the TRIO system follow these steps:

1. Twist the two locking cam latches such that they are vertical to the short edge of the unit. (See Figure 1)
2. Remove the door at an angle, from the cam latch side first. (See Figure 2)



FIGURE 1



FIGURE 2

To replace the door to the TRIO system follow these steps:

1. Insert the flange of the door into the filter side of the cabinet. (See Figure 3)
2. Close the door at an angle. Twist the 2 locking cam latches such that they are horizontal to the short edge of the unit. (See Figure 4)



FIGURE 3



FIGURE 4

## TRIO INSTALLATION INSTRUCTIONS

### *INSTALLATION INSTRUCTIONS FOR TRIO LAMP*

**NOTE:** Due to directional airflow installation options, the Healthy Home System 3x3 Product Brand Label is enclosed for proper upright placement at the field installation. The TRIO installation is specific to direction of airflow and must be properly positioned when choosing upflow, downflow, or horizontal airflow application. Pay attention to directional airflow arrow for proper installation. The TRIO is designed to be installed on indoor HVAC forced air ducted systems. Do Not install TRIO on the supply air side of HVAC equipment. Do Not install outdoors. Product is not designed to be exposed to outdoor elements.



**WARNING:** Disconnect power to all equipment before beginning this installation! Refer to all warning and cautionary statements as given in the included main installation instructions!



**WARNING:** Never expose eyes or skin to UVC light from any source. Looking directly at the UVC light may cause permanent eye damage or blindness. Never operate the Trio Air Purifying System out of the ductwork. Avoid touching the glass portion of the lamp with your hands.



**WARNING:** Make sure unit is unplugged before installing the lamp.

## INSTALLATION

Make sure to install the TRIO Healthy Home Purification System so that the inlet or return air enters the side containing the MERV13 particulate reduction cartridge first.

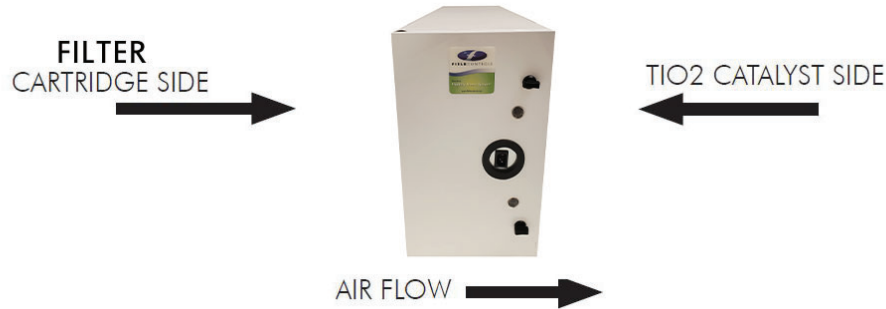

TYPICAL VERTICAL AND HORIZONTAL INSTALLATION

1. Remove the door to the unit per the steps listed previously.
2. Remove the inside module & filter from the outer cabinet. Take care not to bend or distort the cabinet. The ballast is factory set to 120VAC. Please confirm the voltage on both ballasts is correct. The voltage can be changed in the field to 230VAC by sliding the voltage selector switch in Figure 5 to the 230 volt position. The plug must be replaced and wiring must be done to applicable electrical codes.
3. Mount the outer cabinet to the support plenum.

**NOTE:** Do not use a screw length that will extend into or penetrate the inside module containing the TiO<sub>2</sub> catalyst or filter cartridge.



FIGURE 5

4. In some cases the foot print of the air handler may be larger or smaller than the outer enclosure of the TRIO Unit. A metal adapter plate of 18 ga. metal should be fabricated to make a suitable transition. (Figure 6)

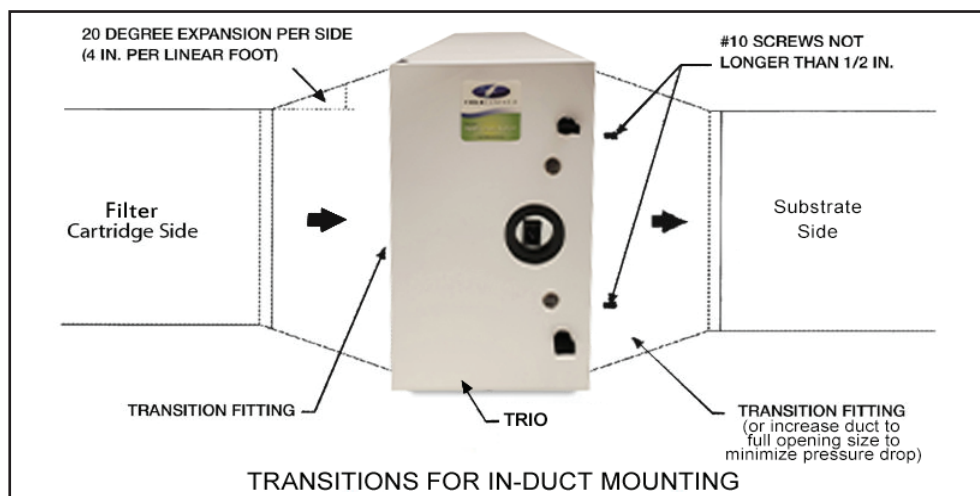

FIGURE 6



**WARNING:** Never expose eyes or skin to UVC light from any source. Looking directly at the UVC light may cause permanent eye damage or blindness. Never operate the Trio Air Purifying System out of the ductwork. Avoid touching the glass portion of the lamp with your hands.

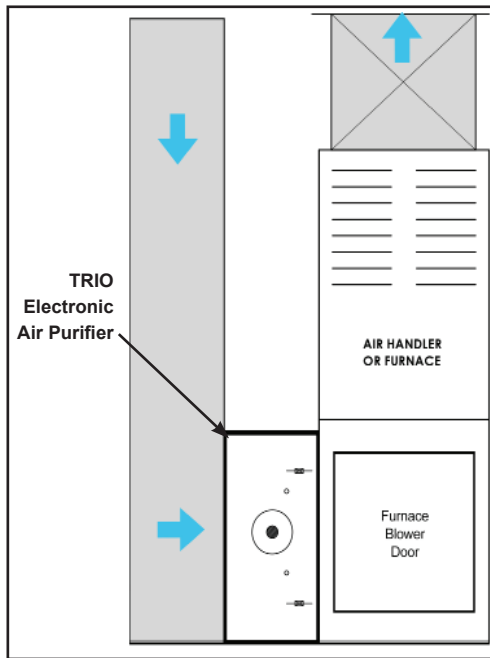

FIGURE 7A -  
Upflow Side Return

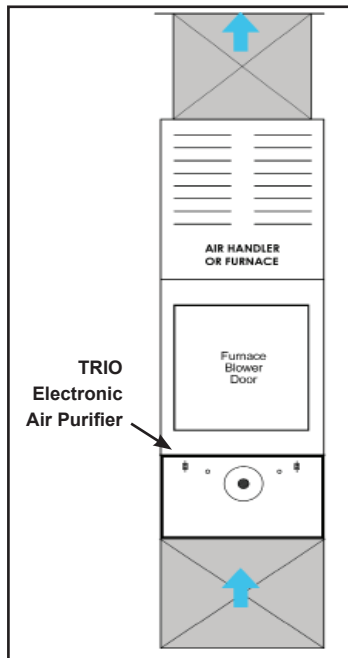

FIGURE 7B -  
Upflow Bottom Return

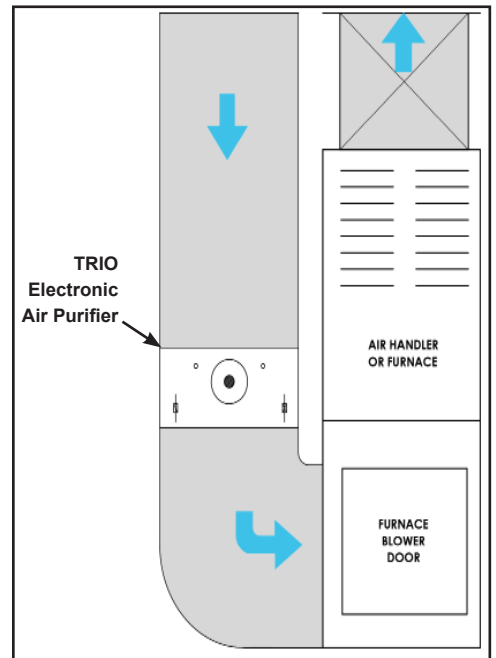

FIGURE 7C -  
Reduction of Static Pressure

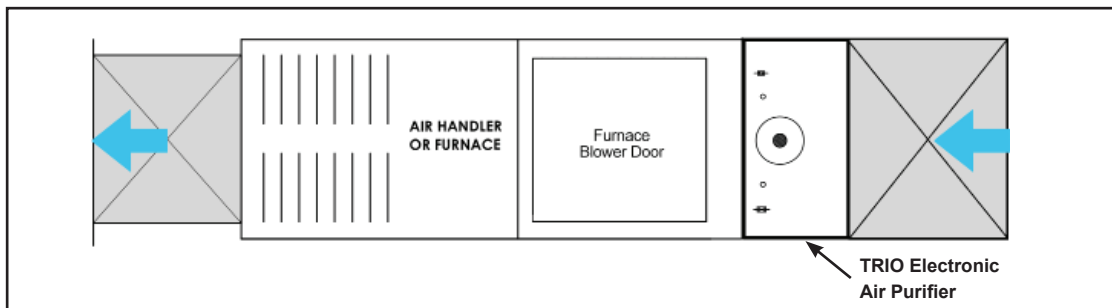

FIGURE 8 - Horizontal End Return

5. Seal all seams with an approved air duct sealant between the air handler and the outlet side of the TRIO so that there can be no air bypassing the system.
6. Attach the air handler to the outlet side of the TRIO and fasten with #10 x 3/8 self-drilling sheet metal screws.
 

**NOTE:** Only 1/2 inch of clearance has been provided between the outer and inner case.
7. Slide the filter into the upstream slot of the cabinet, ensuring the correct air flow direction. Slide the inner module into the downstream slot of the cabinet. The catalytic aluminum substrate should be facing downstream such that the lamps are not exposed to the open duct.
8. Replace the door on the unit per the steps listed previously.
9. Plug in the power cord to any 120VAC outlet and check both sight ports to make sure both lamps are illuminated. Ultraviolet lamps must remain on at all times regardless of thermostat or HHSC Control settings.
10. Set the thermostat or the HHSC+ Control to operate the fan unit for at least 20-30 minutes every hour. If air quality problems persist after one week, increase the fan unit operating time by (5) minute intervals.



**WARNING:** Never expose eyes or skin to UVC light from any source. Looking directly at the UVC light may cause permanent eye damage or blindness. Never operate the Trio Air Purifying System out of the ductwork. Avoid touching the glass portion of the lamp with your hands.

## MAINTENANCE



**WARNING: Disconnect power to the unit before commencing inspection and cleaning.**

**NOTE:** Wear disposable, non-absorbent protective gloves prior to inspection procedure in case of accidental breakage of glass.

1. We recommend inspecting and cleaning the lamp at least every 6 months. Frequency depends upon the environment. Such as: the type of air filter, duration of use and replacement cycle.
2. To maintain maximum output intensity, replace the UV lamp annually. The lamp should operate continuously for maximum lamp life and light effectiveness.
3. Replace the MERV13 filter every six (6) months.
4. Do not attempt to clean the catalytic aluminum substrate with cleaning solutions. The catalyst is radiated with short wave ultraviolet light during period of non-air flow and is self-cleaning. If there is build up blocking the catalytic cells, sit the unit on end, on a flat surface, with electrical enclosure facing up. Use low-pressure, compressed air to blow the surface of the catalytic cells free of blockage.

## TRACKING FILTER AND UV LAMP SERVICE TIME

Under normal conditions, the Filter should be changed out every 180 days. Under normal conditions, the UV Lamp should be changed out every 365 days. Contact your local Field Service Contractor or Distributor for replacement parts. Replacement part numbers are provided in parts list section of this manual.

There are several ways to track the remaining useful life of media Filter and UV Lamp:

1. Use Field Controls Healthy Home System Control Plus (HHSC+) device
2. Use Field Controls Manual Tracking Filter/Lamp Sticker

**Healthy Home System Control Plus (HHSC+)** will automatically alert the homeowner via HHSC+ status LED will turn red and display on the screen to replace the HVAC filter and/or UV Lamp. The Filter and UV Lamp replacement period is adjustable on HHSC+ device. Refer to Field Controls Healthy Home System Control Plus instruction sheet (doc: 46633800) for additional information. This document is available on the Field Controls Web Site ([www.FieldControls.com](http://www.FieldControls.com)). The HHSC+ can be purchased separately. Contact your local contractor.

**Manual Tracking Filter/Lamp Sticker** (p/n: 75000002000) can be manually installed on the door of the TRIO unit by the homeowner or contractor. The sticker is designed to handle two Filter replacements to every one UV Lamp replacement. The replacement dates must be manual written on the sticker by the homeowner or HVAC contractor. The filter/lamp replacement sticker can be purchased from Field Controls as a separate item.

Replacement Reminder	
Filter	UV Lamp
_____	_____
installed date	installed date
Replace every 6 months	Replace annually
P/N 75000002000	



**WARNING:** Never expose eyes or skin to UVC light from any source. Looking directly at the UVC light may cause permanent eye damage or blindness. Never operate the Trio Air Purifying System out of the ductwork. Avoid touching the glass portion of the lamp with your hands.



## CLEANING THE LAMP

**WARNING:** Disconnect power to the transformer or unplug the 120V power cord before starting replacement procedure.

NOTE: Wear disposable, non-absorbent protective gloves prior to replacement procedure in case of accidental breakage of glass.

1. Unplug the quick disconnect power cord from the TRIO.
2. Remove the door to the unit per the steps listed previously.
3. Remove the inside module from the outer cabinet.
4. Unplug UVC germicidal lamps, loosen retaining cam latches, and remove lamps. (See Figures 9 , 10 & 11)

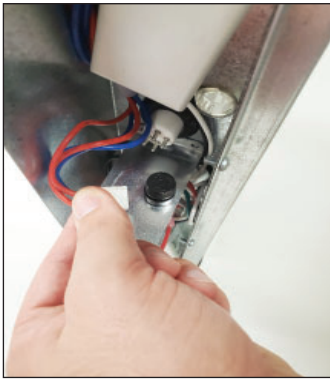

FIGURE 9



FIGURE 10



FIGURE 11

5. Use a cotton cloth with isopropyl alcohol and gently clean the surface of the lamp.
6. Slide the lamp back into the module. Tighten the retaining cam latch (finger tight ONLY or the lamp may be damaged). Plug the ballast connector back on to the lamp.

## REPLACING THE LAMP

Recommended every (12) months of continuous service.

Replace only with a Part# 46636400 germicidal replacement lamp.

Follow the above steps to remove the lamp. Replace with the new replacement lamp.

NOTE: If blue light leaks through any portion of ductwork, unplug power supply cord immediately and seal affected areas.

UV lamps contain a small amount of mercury, like a typical fluorescent lamp. Check with your local waste management authority for local disposal or recycling requirements. According to the EPA's Universal Waste Rule, these types of lamps may be disposed of into household waste.

**WARNING:** Never touch broken lamp or internal contents of lamp. The lamp contains mercury.

NOTE: In case of accidental exposure to internal contents of lamp, wash hands and any other affected skin area with mild detergent. Remove affected clothing immediately. If skin surface is pierced, seek medical attention immediately.

**WARNING:** Never expose eyes or skin to UVC light from any source. Looking directly at the UVC light may cause permanent eye damage or blindness. Never operate the Trio Air Purifying System out of the ductwork. Avoid touching the glass portion of the lamp with your hands.

## CHANGING THE PARTICULATE REMOVAL CARTRIDGE (FILTER)

1. Unplug the power cord from the TRIO.
2. Remove the door to the unit per the steps listed previously.
3. Remove old filter cartridge and replace with new filter. Make sure airflow arrow on filter is pointing to the inside of module. (See Figure 13)
4. Replace the door on the unit per the steps listed previously. Return power to unit.



FIGURE 12



FIGURE 13

## TROUBLESHOOTING GUIDE

1. Check to be sure there is correct voltage to the unit and the ballast is set for the correct voltage.
2. Be sure the lamp connector is fastened securely.
3. Check for loose electrical connections.
4. Test with new lamp and if lamp still does not light, replace ballast.

## REPLACEMENT PARTS LIST

Replacement Part Number	
46636400	Replacement UVC Lamps (Set of 2)
46683600	BTO-12/20 Replacement Ballast Assembly
731011625	TRIO1625RM13C Merv 13 Filter w/ Carbon
731012025	TRIO2025RM13C Merv 13 Filter w/ Carbon
808021200	Catalytic Aluminum Substrate (TRIO-16 & TRIO-16HHS)
80802000	Catalytic Aluminum Substrate (TRIO-20 & TRIO-20HHS)

For replacement parts, contact Field Controls at:

Phone: 252-522-3031 • Fax: 252-522-0214

Email: [sales@fieldcontrols.com](mailto:sales@fieldcontrols.com)



**WARNING:** Never expose eyes or skin to UVC light from any source. Looking directly at the UVC light may cause permanent eye damage or blindness. Never operate the Trio Air Purifying System out of the ductwork. Avoid touching the glass portion of the lamp with your hands.

## CLEAN-UP OF BROKEN LAMPS

UV lamps contain a small amount of mercury, like a typical fluorescent lamp. DO NOT touch any of the mercury with your bare hands.

1. While wearing disposable, non-absorbent protective gloves, carefully pick up the large pieces of glass with your hands.
2. Vacuum the entire area with a standard household vacuum cleaner ensuring the removal of all lamp material.
3. Dispose of the pieces of glass, the vacuum cleaner bag, and the disposable gloves in a sealed garbage bag.
4. Check with your local waste management authority for local disposal or recycling requirements. According to the EPA's Universal Waste Rule, these types of lamps may be disposed of into household waste.
5. Wash hands, and remove and wash clothes for added safety measures.

## WIRING DIAGRAM

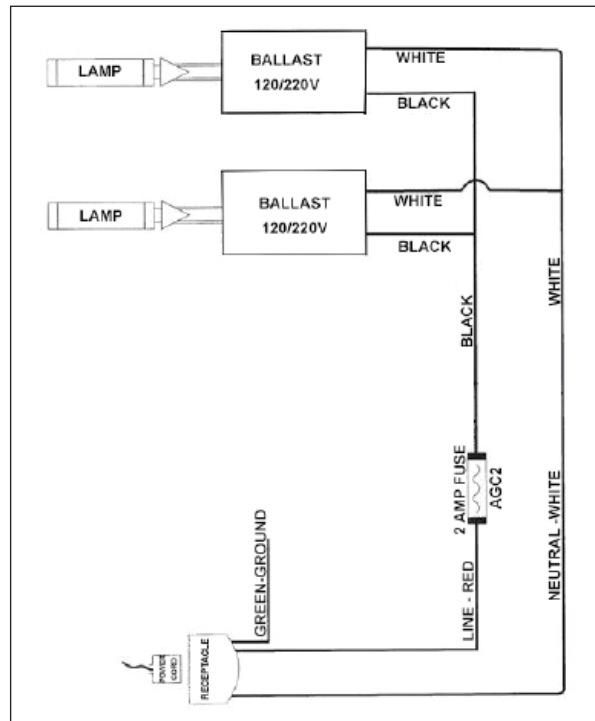

## PRODUCT LABEL PLACEMENT

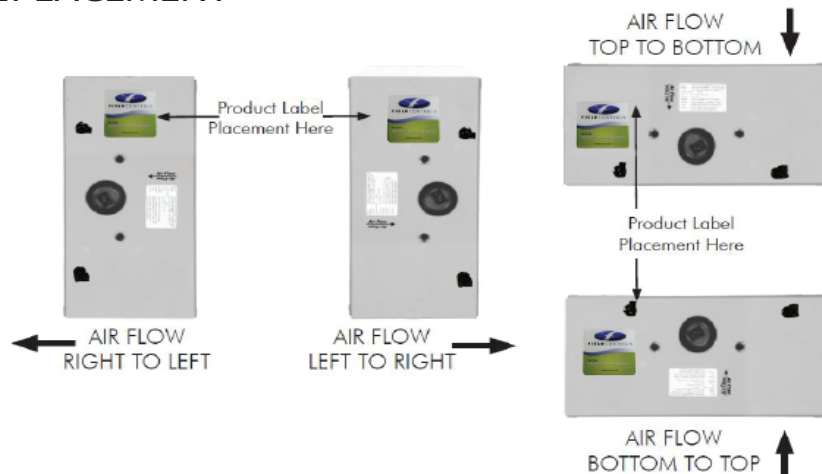

**WARNING:** Never expose eyes or skin to UVC light from any source. Looking directly at the UVC light may cause permanent eye damage or blindness. Never operate the Trio Air Purifying System out of the ductwork. Avoid touching the glass portion of the lamp with your hands.

This manual may be downloaded and printed from the Field Controls website ([www.fieldcontrols.com](http://www.fieldcontrols.com))

**WARRANTY**

For warranty information about this or any Field Controls product, visit:  
[www.fieldcontrols.com](http://www.fieldcontrols.com)

Field Controls Technical Support  
1.800.742.8368  
[fieldtec@fieldcontrols.com](mailto:fieldtec@fieldcontrols.com)



**FIELD CONTROLS**  
Phone: 252.522.3031 • Fax: 252.522.0214  
[www.fieldcontrols.com](http://www.fieldcontrols.com)